

Manual

Software L-LAS-RL-Scope V4.0

(PC software für Microsoft® Windows® 7, 8, 10)

for laser line sensors of the L-LAS-RL Series and L-LAS-CAM Series

L-LAS-RL-CON1 + L-LAS-RL-15-FE

L-LAS-RL-CON1 + L-LAS-RL-30-FE

L-LAS-RL-10-... (-CL)

L-LAS-RL-20-... (-CL)

L-LAS-RL-30-... (-CL)

L-LAS-RL-40-... (-CL)

L-LAS-RL-50-... (-CL)

L-LAS-RL-150- ...

L-LAS-CAM-256

L-LAS-CAM-512

L-LAS-CAM-1024

0 Contents

0	CONTENTS	2
1	FUNCTIONAL PRINCIPLE: L-LAS-RL LINE SENSORS	3
1.1	Technical description	3
2	INSTALLATION OF THE <i>L-LAS-RL-SCOPE</i> SOFTWARE	4
3	OPERATION OF THE <i>L-LAS-RL-SCOPE</i> SOFTWARE	5
3.1	Control elements of the <i>L-LAS-RL-Scope</i> software:.....	6
3.2	Numeric and graphic display elements:.....	17
3.3	Serial RS232 data transfer:.....	19
3.4	<i>L-LAS-RL-Scope</i> as an aid for sensor adjustment:	21
3.5	<i>L-LAS-RL-Scope</i> as an aid for transmitter power adjustment:	22
4	EVALUATION MODES	23
4.1	LEFT-EDGE	23
4.2	RIGHT-EDGE	23
4.3	WIDTH	24
4.4	CENTER	24
5	FUNCTION OF THE DATA RECORDER	25
5.1	Data format of the output file	26
5.2	3-Byte RS232 data transfer	27
6	CCD CALIBRATION	29
7	ANNEX	31
7.1	Function of the TEACH/RESET button.....	31
7.2	Function of the tolerance potentiometer	32
7.3	Function of digital inputs IN0 and IN1	32
7.4	Connector assignment	35
7.5	Alignment of the CCD line / Visualisation LED	36
7.6	RS232 interface protocol	37

1 Functional principle: L-LAS-RL line sensors

1.1 Technical description

In the sensors of the *L-LAS-RL* series the measurement object is illuminated with best possible homogeneous light distribution by means of a ring light comprising several LEDs. The transmitter light sources (LEDs) are available in various wavelength ranges (W:=white light LED, R:=red light LED (640nm), B:=blue light LED (520nm), and UV:=ultraviolet LED).

The sensor's receiver optics unit is equipped with a CCD line that comprises many closely adjacent, individual receiver elements (pixels) that are arranged in a line. The light quantity of each of these receiver elements that accumulates during the exposure time can be separately read out as an analog voltage, and after analog-digital conversion can be stored as a digital value in a data field (video information).

If there is a non-transparent measurement object in the sensor's reference distance, the light that is reflected from the object surface is mapped on the individual pixels of the CCD line. Depending on the reflectance of the object surface certain areas of the line's receiver elements (pixels) will be more illuminated, and other areas of the line will be less illuminated. As a result the pixels within the less illuminated zone will provide a considerably lower analog voltage than pixels that are better illuminated.

Suitable software algorithms are used to determine the shadow zones and the better illuminated zones from the video image. Since the distance of the pixels on the CCD line and the distance from the measurement object are known, the size and position of the differently well reflecting areas of the measurement object can be determined.

The sensors of the *L-LAS-RL* series feature a microcontroller that can be parameterised with a Windows PC software through the serial RS232 interface. Various evaluation modes can be set at the sensor. The housing of the control unit features a TEACH/RESET button and a potentiometer [1] for tolerance setting. Switching states are visualised by several LEDs (red, yellow, green) that are integrated at the housing of the *L-LAS-RL* sensor. The *L-LAS-RL* control unit has three digital outputs (OUT0, OUT1, OUT2) with software-adjustable output polarity. Two digital inputs (IN0, IN1) can be used to provide an external TEACH/RESET functionality and an external TRIGGER functionality by means of a PLC. The control unit also provides a high-speed analog output (0...10V) and a current output (4...20mA) with 12-bit digital/analog resolution.

[1] not available with all model ranges



Picture: L-LAS-RL-...-CL



Picture: L-LAS-RL-...

2 Installation of the *L-LAS-RL-Scope* software

Hardware requirements for successful installation of the *L-LAS-RL-Scope* software:

- Microsoft® Windows® 7, 8, 10
- IBM PC AT or compatible
- VGA graphics
- Microsoft-compatible mouse
- Serial RS232 interface at the PC or USB slot or RJ45 connector
- Cable **cab-las4/PC** for the RS232 interface or **cab-4/USB** USB converter or **cab-4/ETH** Ethernet converter

Please install the software as described below:

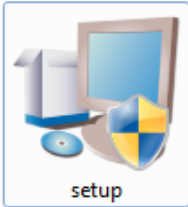
1.	<p>You can download the software via a provided download link or, if applicable, install it via the provided software DVD. To install the software, start the 'SETUP' program in the 'SOFTWARE' folder.</p>
2.	<div style="display: flex; align-items: center;">  <div style="padding: 5px;"> <p>The installation program displays a dialog and suggests to install the software in the C:\'FILENAME' directory on the hard disk. You may accept this suggestion with OK or [ENTER], or you may change the path as desired. Installation is then performed automatically.</p> </div> </div> <p>During the installation process a new program group for the software is created in the Windows Program Manager. In this program group an icon for starting the software is created automatically. When installation is successfully completed the installation program displays a "Setup OK" message.</p>
3.	<p>The <i>L-LAS-RL-Scope</i> software can then be started with a mouse click on the corresponding symbol in the newly created program group under: Start >All Programs > L-LAS-RL-ScopeV4.00</p> <div style="border: 1px solid gray; background-color: #fff9c4; padding: 5px; margin-top: 10px;"> <div style="display: flex; align-items: center; margin-bottom: 5px;"> L-LAS-TB-ScopeV400nn </div> <div style="display: flex; align-items: center;"> L-LAS-TB-ScopeV400nn </div> </div>

Windows™ is a registered trademark of Microsoft Corp.
 VGA™ is a trademark of International Business Machines Corp.

Deinstallation of the *L-LAS-RL-Scope* software:

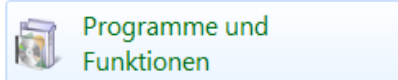
	<p>Please use the Windows deinstallation tool to remove the software. The Windows deinstallation tool can be found under</p> <p style="text-align: center;">Start / Settings / Control Panel.</p>
--	---

3 Operation of the *L-LAS-RL-Scope* software

The *L-LAS-RL-Scope* software is used for parameterizing the electronic control unit used for controlling the *L-LAS-RL* line sensors. The measured values provided by the sensor can be visualized with the PC software, which means that the software among others can be used for adjustment purposes and for setting suitable tolerance limits for the inspection of the measuring object.

Data exchange between the PC user interface and the sensor system is effected through a standard RS232 interface. For this purpose the sensor is connected to the PC with the serial interface cable cab-las4/PC. When parameterization is finished, the setting values can be permanently saved in an EEPROM memory of the *L-LAS-RL control unit*. The sensor system then continues to operate in "STAND-ALONE" mode without the PC.

When the *L-LAS-RL-Scope* software is started, the following Windows® user interface will be displayed:

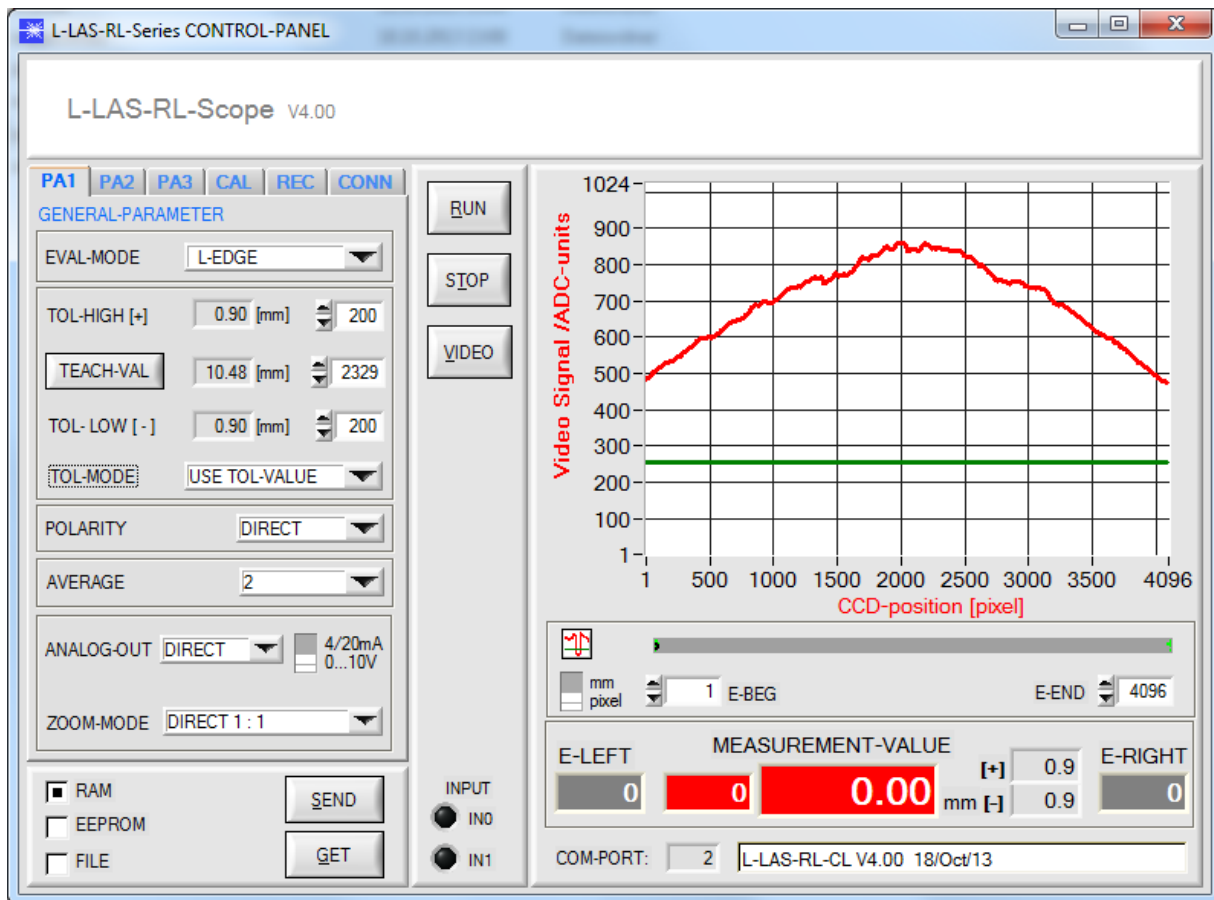

The *L-LAS-RL-Scope* CONTROL PANEL provides a great variety of functions:

- Visualization of measurement data in numeric and graphic output fields.
- Setting of the laser power for the laser transmitter.
- Setting of the polarity of the digital switching outputs OUT0, OUT1, and OUT2.
- Selection of a suitable evaluation mode.
- Presetting of setpoint value and tolerance band.
- Saving of parameters to the RAM, EEPROM memory of the control unit, or to a configuration file on the hard disk of the PC.

The following chapters provide explanations of the individual control elements of the *L-LAS-RL-Scope* software.

3.1 Control elements of the L-LAS-RL-Scope software:

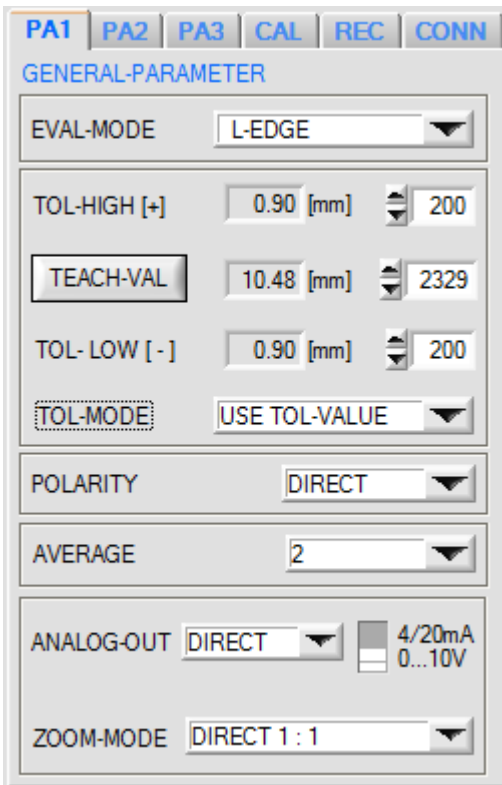

PA1:

A click on the PA1 button opens the PARAMETER I window, where various general parameters at the control unit can be set.



Attention !



Changes that are made in the function fields described below only become active at the control unit of the L-LAS-RL sensor after a click on the SEND button!

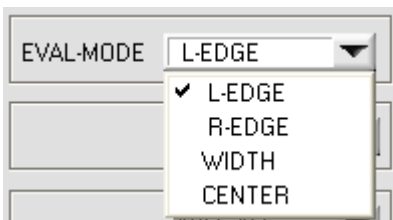

EVAL-MODE:

This list selection field serves for setting the evaluation mode at the L-LAS-RL sensor. Depending on the evaluation mode that is currently set, the edges created from the video signal (intensity profile) of the CCD line will be assessed differently.

L-EDGE:

The 1st edge (left edge) of the CCD line's intensity profile, starting with the first pixel, is used as measurement value.

R-EDGE:

The 1st edge (right edge) of the CCD line's intensity profile, starting with the last pixel, is used as measurement value.

WIDTH:

The difference between the second and the first edge is used as measurement value: $WIDTH = R-EDGE - L-EDGE$

CENTER:

The mean value of the first edge and the second edge is used as measurement value: $CENTER = (L-EDGE+R-EDGE)/2$

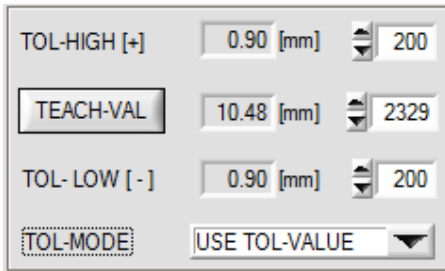

TOLERANCE-HIGH[+], TOLERANCE-LOW [-]:

In these input fields an upper and lower value for the tolerance window can be set by entering a numerical value or by clicking on the arrows (pixel values). The tolerance window is applied symmetrically around the setpoint value (TEACH-VALUE) and is framed by the upper and lower tolerance threshold.

The tolerance values that are currently set at the sensor are shown next to the pixel input fields in [mm].

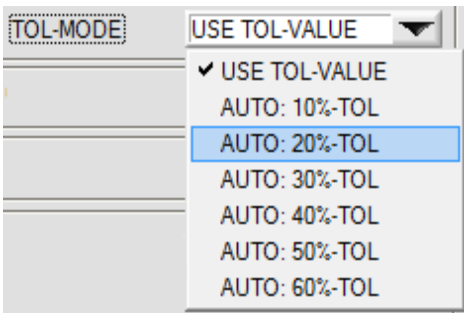

AUTO-TOLERANCE [%]:

This list function element can be used to activate the automatic calculation of the tolerance bandwidth.

Using the respective current TEACH-IN value a percentage tolerance bandwidth is automatically set.

Example: TEACH-VAL = 2048 pixel

AUTO: 10%-TOL

Result: TOL-HIGH = 204 pixel, TOL-LOW = 204 pixel

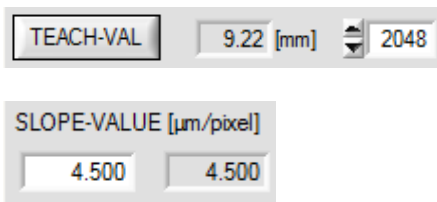

TEACH-VALUE [Pixel]:

Numeric input field for setting the current teach value (setpoint value) in pixels. The teach value that is set here only is activated at the *L-LAS-RL* sensor after a click on the SEND button.

The teach value is set in pixels. As with the tolerance value, conversion into µm can be done by means of the SLOPE-VALUE (sensitivity – µm/pixel).

Example for the teach value with the values shown in the screenshots:

$$TEACH_VALUE [mm] = SLOPE * TEACH [Pixel]$$

$$TEACH_VALUE [mm] = 4.500[um/Pixel] * 2048[Pixel] = 9.22 mm$$

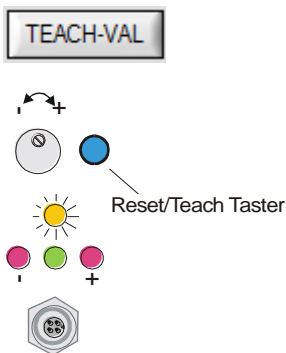

After a click on the TEACH-VAL button the current edge information is stored as a teach value to the RAM memory of the *L-LAS-RL* sensor. Depending on the evaluation mode that has been set (E-MODE), the left edge, the right edge, the width (WIDTH), or the center position (CENTER) will be stored as a teach value in the RAM memory of the *L-LAS-RL* sensor.

When the teach process is completed, the yellow LED at the housing of the *L-LAS-RL* sensor quickly blinks 3 times.

The teach process also can be started by means of the TEACH/RESET button at the housing (pressing the button for t > 1.5s) or by way of a high level at digital input IN1/yellow/pin4 (t > 1.5s).

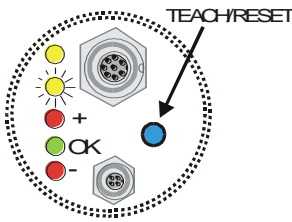

L-LAS-RL-... (M34) types:

With sensors of type L-LAS-RL-... (M34) the teach process can be started by pressing the button at the housing or by applying a LOW voltage (GND) at digital input IN0/green/pin3.

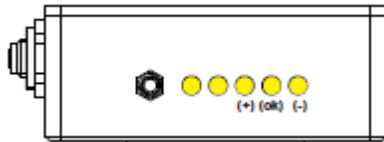

L-LAS-RL-...-CL types:

With sensors of type L-LAS-RL-...-CL the teach process can be started by pressing the button at the housing ($t > 1.5s$) or by applying a HIGH voltage (+24VDC) at digital input IN1/yellow/pin4 ($t > 1.5s$).

For enabling the button at the housing, the ENABLE-BTN function must first be activated at the sensor in the PARAMETER III input window.

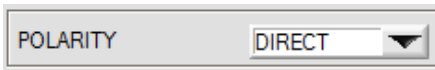
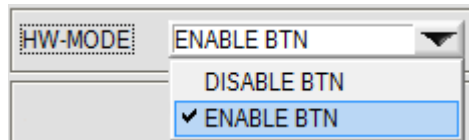

POLARITY:

In this function field the output polarity at the *L-LAS-RL sensor* can be set with a mouse-click. The *L-LAS-RL sensor* has 3 digital outputs (OUT0, OUT1, OUT2) through which error states can be sent to the PLC.

DIRECT:

In case of an error, the respective digital output is set to +Ub (+24VDC, red LED on).

INVERSE:

In case of an error, the respective digital output is set to the reference potential (GND/0V, red LED on).

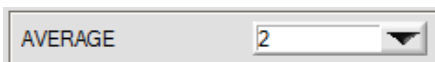

AVERAGE:

In this function field the averaging at the *L-LAS-RL sensor* can be selected with a mouse-click on the respective list item. With every cycle of the main program the current measurement value is stored in a ring memory field, and then the average of these values in the ring memory field is calculated.

The average of the ring memory field is used as the MEASUREMENT_VALUE. With the AVERAGE value the size of the ring memory can be set from 1 to 256. The measurement value that is determined by this also is provided at the analog output pin8/red/.

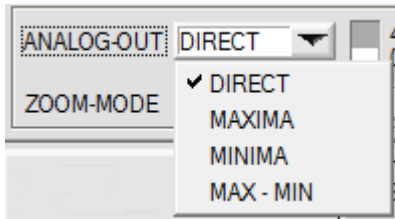

ANALOG-OUT (Analog-Output-Mode):

Function element for selecting the output mode of the analog voltage at the *L-LAS-RL sensor* (pin8/red 8-pol. PLC/POWER female connector). The analog voltage is output in the range from 0 to 10V with a resolution of 12 bit.

DIRECT:

A voltage (0...10V) that is proportional to the current measurement value is provided at the analog output pin8/red.

MAXIMA:

The current maximum value is provided at the analog output pin8/red/ (drag pointer principle, resetting by input IN1/pin4/yellow pulse of <750ms length, or by pressing the TEACH/RESET button).

MINIMA:

The current minimum value is provided at the analog output pin8/red/ (drag pointer principle, resetting by input IN1/pin4/yellow pulse of <750ms length, or by pressing the TEACH/RESET button).

MAX-MIN:

The current difference between maximum and minimum value is provided at the analog output pin8/red/ (drag pointer principle, resetting by input IN1/pin4/yellow pulse of <750ms length, or by pressing the TEACH/RESET button).

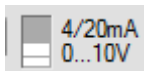

0...10V / I-OUT:

Selector switch for setting the operating mode at analog output pin8/red/.

0...10V:

Analog output = voltage output 0...10V.

4/20mA:

Analog output = current output 4... 0mA

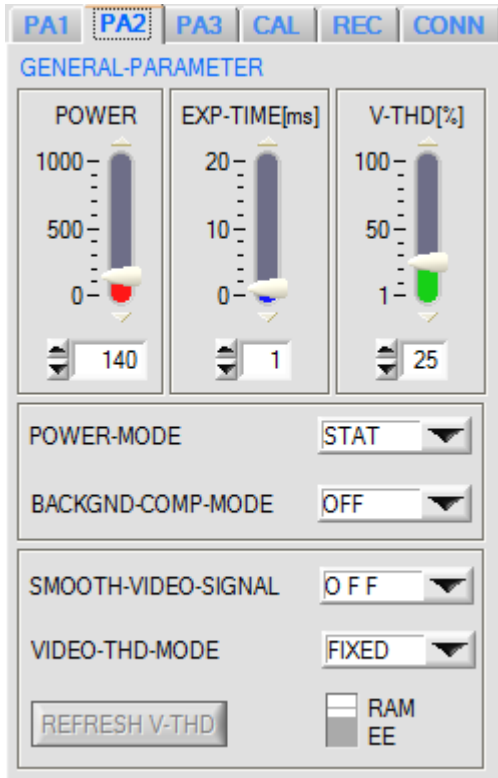

PA2:

A click on the PA2 button opens the PARAMETER II window, where additional parameters at the control unit can be set.



Attention !



Changes that are made in the function fields described below only become active at the control unit of the L-LAS-RL sensor after a click on the SEND button!

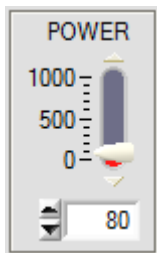

POWER:

In this function field the transmitter power at the lighting unit of the L-LAS-RL sensor (LED ring illumination) can be set by using the arrows or the slider, or by entering a numerical value in the respective input field.

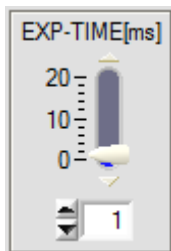

EXPOSURE-TIME[ms]:

In this function field the exposure time at the L-LAS-RL sensor can be set by using the arrows or the slider or by entering a numeric value in the respective input field. With very dark or matt surfaces, increasing the exposure time may help to ensure that sufficient light intensity arrives at the CCD line. A longer exposure time reduces the scan frequency of the sensor. (e.g. 2ms=500Hz, 10ms=100Hz).



POWER-MODE:

In this list function field the power control mode for the LED ring light can be set.

STAT:

Static (constant) power of the LED ring light.

DYN:

LED power is set dynamically during operation. Power control attempts to keep the maximum value of the video profile in the range between 600 and 800 ADC units.

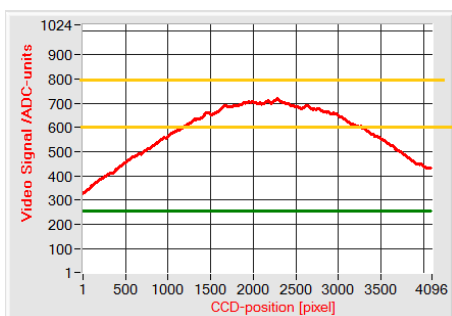

BACKGND-COMP-MODE

BACKGND-COMP-MODE:

In this list function field the operating mode for background compensation at the sensor can be set.

OFF:

Background compensation is off.

ON:

Automatic background compensation is on. In this mode the light power of the LED ring light is cyclically turned on and off. In off state the background image (dark video image) is saved. When the LED ring light is on, the previously saved dark video image is mathematically, pixel by pixel, subtracted from the current bright video image. The resulting video image is evaluated.

With active background compensation the sensor operates with half its scan frequency.

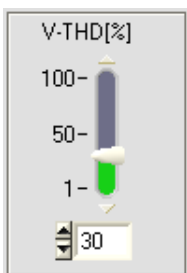

FIXED-Video Threshold

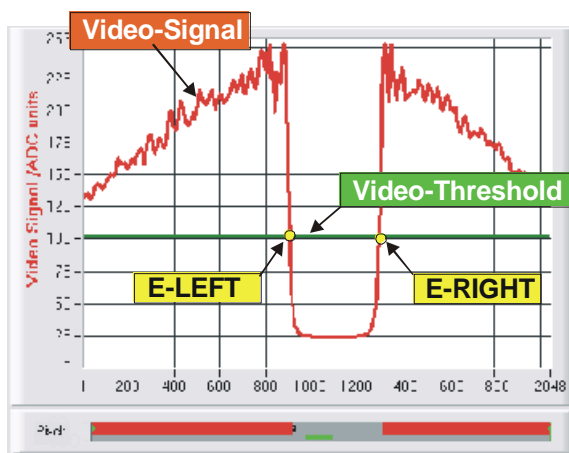

FIXED-VIDEO-THD[%]:

In this function field the video threshold at the *L-LAS-RL* sensor can be set by entering a numerical value or by using the slider or the arrows. With the help of this video threshold the measurement values can be derived from the intensity characteristic (video signal) of the CCD line from the bright/dark transitions.

For this purpose the intersection points between the intensity profile (red curve) and the adjustable video threshold (green horizontal line) are calculated and stored.

The x-value of the respective intersection point is assigned to a pixel on the CCD line. The measurement value can be calculated from this information and from the known distances of the pixels on the CCD line. The intersection points between intensity profile and video threshold that are provided by this method are hereinafter referred to as edges.

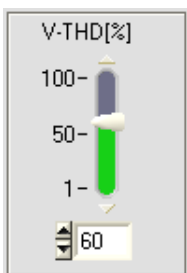

AUTO-Video Threshold

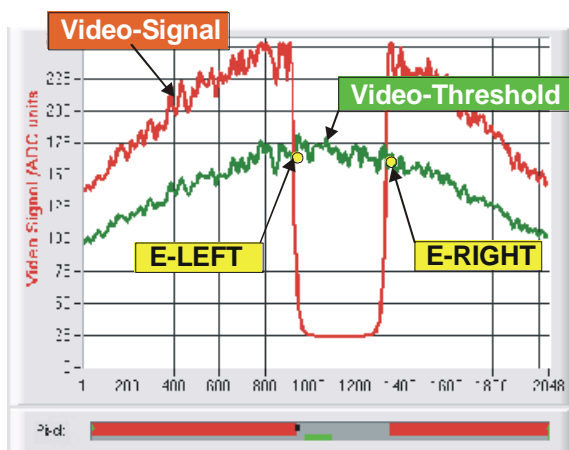

AUTO-VIDEO-THD[%]:

When the toggle switch is in AUTO position, the threshold that is stored in the non-volatile EEPROM/RAM of the sensor is used as video threshold.

This threshold (green curve) is not a horizontal line, but is derived from the intensity characteristic of the laser transmitter and thus "tracks" the intensity profile.

As before the measurement values are derived from the intensity characteristic of the CCD line (red curve) and the tracked video threshold (green curve). For this purpose the intersection points between intensity profile and tracked video threshold are calculated again.

VIDEO-THD-MODE

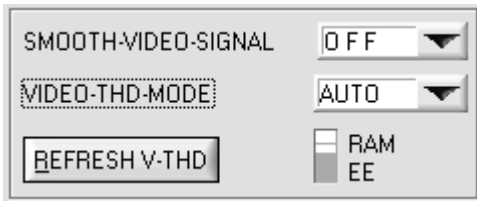

VIDEO-THD-MODE AUTO:

The automatic follow-up threshold mode is activated by selecting AUTO from the VIDEO-THD-MODE drop-down list field.

RAM: The video threshold is saved in the volatile RAM memory.

EE: The video threshold is saved in the non-volatile EEPROM memory.

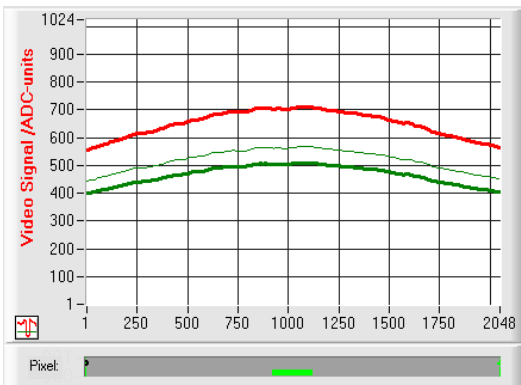

The current threshold can be changed by clicking on the arrow keys in the V-THD[%] slider.

The new video threshold first is shown as a thin green curve. This threshold (green curve) is not a horizontal line but is derived from the intensity characteristic of the video signal (red curve) and thus "follows" the intensity profile.

The distance between follow-up video threshold and intensity profile can be chosen very small, which is helpful for the measurement of semi-transparent objects (e.g. foils).



Before the new video threshold is saved there must be no measurement object in the beam path between transmitter and receiver!



REFRESH V-THD:

Only a click on this software button saves the new video threshold in the volatile RAM or permanently in the non-volatile EEPROM memory at the *L-LAS-RL* sensor.

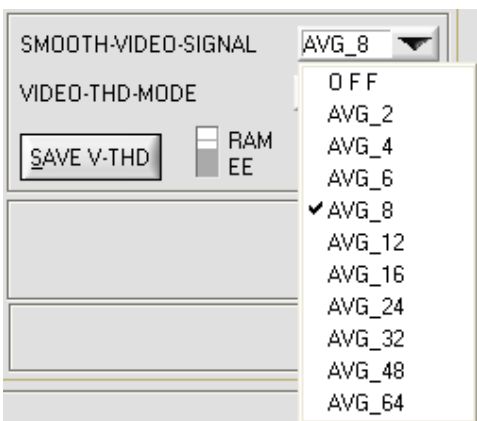

SMOOTH-VIDEO-SIGNAL:

A click on the SMOOTH-VIDEO-SIGNAL drop-down list field opens the setting options for the activation of a digital software filter for the video signal characteristic. If a software filter is activated, corresponding filtering of the video signal will be performed after every scan in the main program run.

With digital software filtering the video signal characteristic can be smoothed, if necessary.

OFF:
The video signal is not filtered.

AVG 2:
The video signal of two adjacent pixels is subjected to averaging.

...

AVG 64:
The video signal of 64 adjacent pixels is subjected to averaging.

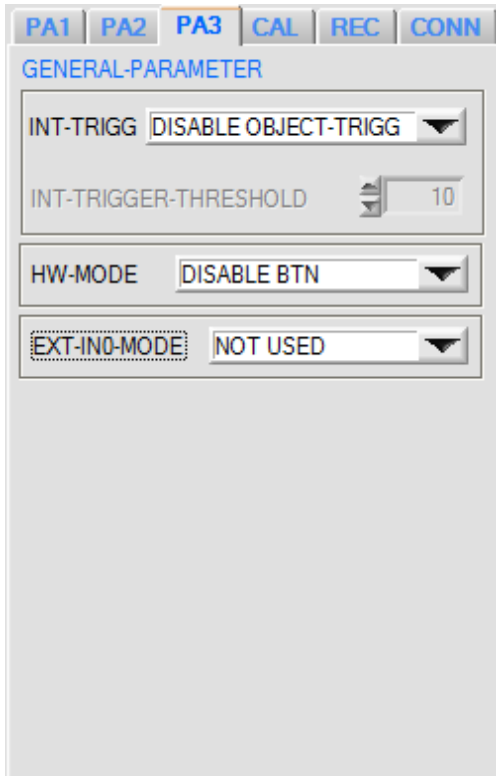

PA3:

A click on the PA3 button opens the PARAMETER III window, where additional parameters at the control unit can be set.



Attention !



Changes that are made in the function fields described below only become active at the control unit of the L-LAS-RL sensor after a click on the SEND button!

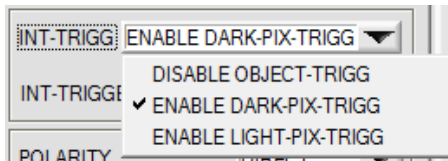

INT TRIGG (internal trigger):

This list selection field is used to set the operating mode for internal triggering.

- DISABLE: No internal triggering.
- ENABLE DARK-PIX: Internal triggering upon "dark pixels" (pixels below the video threshold).
- ENABLE LIGHT-PIX: Internal triggering upon "light pixels" (pixels above the video threshold).

Default value of the trigger threshold for internal triggering.

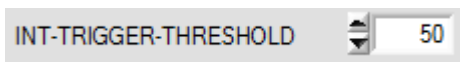

The currently detected trigger pixels are shown in a numeric display field. The display LED becomes orange when there is a trigger event. When internal triggering is active the trigger event is provided as a level change at digital output OUT0/pin5/grey.

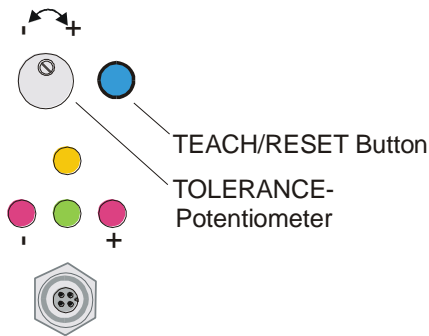
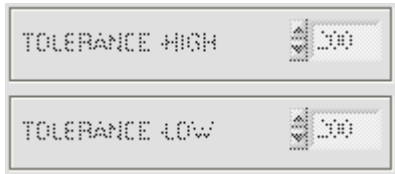
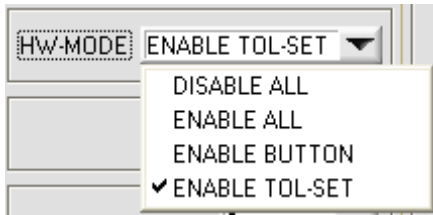

HARDWARE (Hardware-Mode) [1]:

The TOLERANCE potentiometer and/or the TEACH/RESET button at the housing of the *L-LAS-RL sensor* can be activated (ENABLE) or deactivated (DISABLE) by clicking on the respective item in the list selection field.

The TOLERANCE potentiometer allows the presetting of a tolerance window around the setpoint value. If the function field is set to ENABLE ALL or ENABLE TOL-SET, it is not possible to enter numerical values in the TOLERANCE-VALUE input field of the PC software. The respective function fields will be greyed.

DISABLE ALL

Both the TEACH/RESET button and the TOLERANCE potentiometer at the housing are deactivated.

ENABLE ALL:

The TOLERANCE potentiometer at the housing is activated. (clockwise turning increases the tolerance bandwidth)
The TEACH/RESET button at the housing is activated.
Button pressed for a short time ($t < 0.7s$) : RESET function.
Button pressed for a long time ($t > 1.5s$) : TEACH function.

ENABLE BUTTON:

Only the TEACH/RESET button at the housing is activated.

ENABLE TOL-SET:

Only the TOLERANCE potentiometer at the housing is activated.

[1] not available in all models

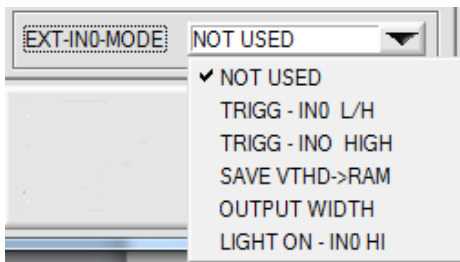

EXT-INO-MODE:

List element for setting the operating mode at digital input IN0/pin3/green.

TRIGG-IN0 L/H:

External edge-controlled triggering of measurement value evaluation through digital input IN0/pin3/green.

TRIGG-IN0 HIGH:

External triggering of measurement value evaluation through a high level (+Ub) at digital input IN0/pin3/green.

SAVE-VTHD ->RAM:

Saving of the follow-up video threshold to the volatile RAM memory upon an edge change at digital input IN0/pin3/green.

OUTPUT WIDTH:

Output of width information upon a level change at input IN0.

LIGHT ON – IN0 HI

Activation of the transmitter LED by a HIGH level at IN0/pin3/green.

GENERAL control elements:



E-BEG:

Numeric input field for entering the beginning of evaluation. The CCD line is evaluated starting from the pixel that is set here (Evaluation-Begin). (Default value = 1).

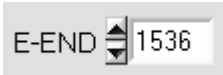

E-END:

Numeric input field for entering the end of evaluation. The CCD line is evaluated up to this pixel. Pixels on the right side of the pixel value that is set here will not be evaluated.

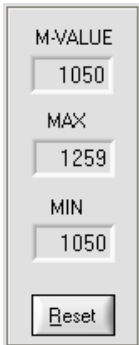

Reset button (maximum-minimum values):

A click on the RESET button resets the current maximum and minimum values that are detected by the *L-LAS-RL sensor*. The numeric display fields show the respective current maximum and minimum value.

Resetting of the maximum and minimum values also can be triggered by a short pulse (duration $t < 750$ ms) at digital input IN1/yellow/pin4 from the PLC. The maximum and minimum values also can be reset by pressing the hardware button at the housing of the *L-LAS-RL sensor*.

Please note:

This RESET function does not perform a hardware/software reset at the *L-LAS-RL sensor*, it only resets the maximum and minimum values!



Status display of digital inputs:

This LED display visualises the states of digital inputs IN0 and IN1.

Please note:

The LED display elements only are refreshed when RUN mode (data exchange through RS232) is active. IN0=HIGH< >LED(green), IN1=HIGH< >LED(yellow)

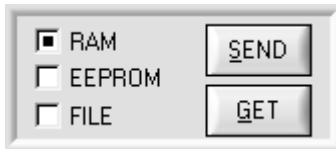

PARAMETER TRANSFER:

This group of function buttons is used for transferring parameters between the PC and the *L-LAS-RL sensor* through the serial RS232 interface.



SEND:

When the SEND button is clicked, the parameters currently set on the user interface are transferred to the *L-LAS-RL sensor*.

The target of data transfer is determined by the selected radio-button (RAM, EEPROM, or FILE).



GET:

When the GET button is clicked, the setting parameters are transferred from the *L-LAS-RL sensor* to the PC and are updated on the user interface. The source of data transfer again is determined by the selected radio-button:

RAM:

The currently set parameters are written to the volatile RAM memory of the *L-LAS-RL sensor*, or they are read from the RAM and transferred to the PC.

Please note: The parameters set in the RAM will be lost when the power supply at the *L-LAS-RL sensor* is turned off.

EEPROM:

The currently set parameters are written to the non-volatile EEPROM memory of the *L-LAS-RL sensor*, or they are read from the EEPROM and transferred to the PC. Parameters that are saved in the EEPROM will not be lost when the power supply is turned off.

If parameters are read from the EEPROM of the *L-LAS-RL sensor*, these must be written to the RAM of the *L-LAS-RL sensor* by selecting the RAM button and then clicking on SEND. The *L-LAS-RL sensor* then continues to operate with the set RAM parameters.

FILE:

When the FILE radio-button is selected, a click on the SEND/GET button opens a new file dialog on the user interface. The current parameters can be written to a freely selectable file on the hard disk of the PC, or parameters can be read from such a file.

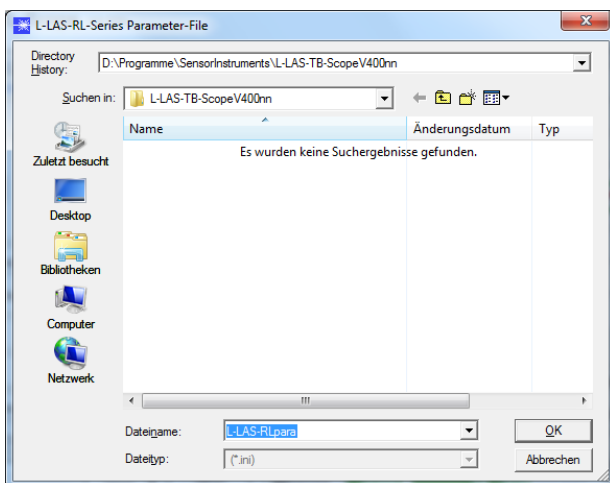

FILE dialog window:

The standard output file for the parameter values has the file name "L-LAS-RLpara.ini".

The output file can be opened e.g. with the standard Windows "EDITOR" program.

3.2 Numeric and graphic display elements:



VIDEO button:

After a click on the VIDEO button, the intensity profile measured at the CCD receiver is transferred to the PC and is shown as a red curve in the graphic display window.

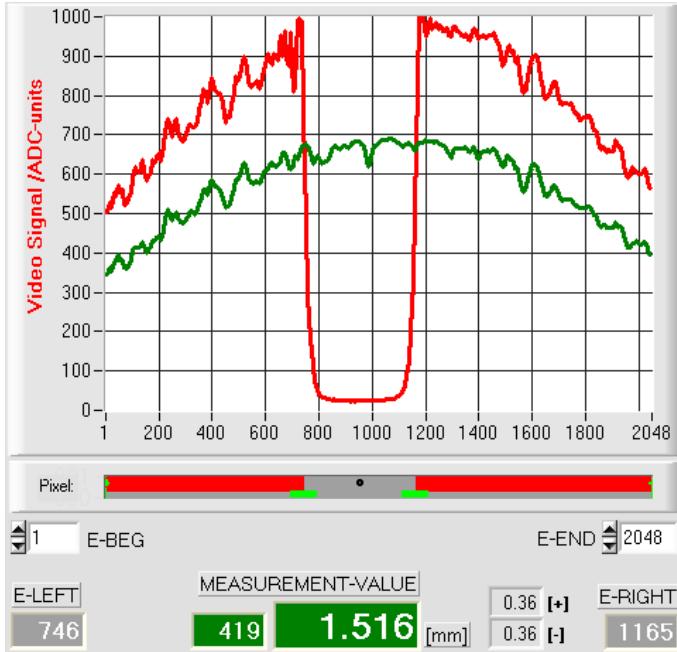

The y-axis shows the analog signals of the individual pixels. The analog values (video signals) of the CCD line are converted by means of an AD converter with 10-bit resolution, which results in a y-axis value range of 0...1023.

The currently set video threshold (V-THD) is shown as a green horizontal line in the graphic display. The edge values (pixels) are derived from the intersection points of the intensity profile (red line) with the video threshold (green line).

The x-axis shows a virtual representation of the individual pixels of the CCD line (for example: Pixel 1...2048).

Because of the limited data transfer rate of the serial interface (19200 Baud/s) the graphic display window can only be updated every second.

Beneath the graphic display window there is another display element that shows the currently detected shadowed areas and the illuminated areas of the CCD line. Furthermore the currently detected edge position is indicated in this display element by way of a black circular cursor. A green horizontal bar represents the width of the tolerance band that is currently set around the teach value.

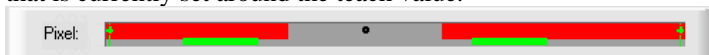

E-LEFT:

Numeric display field that shows the current left edge position.



E-RIGHT:

Numeric display field that shows the current right edge position.



M-VALUE:

Numeric display field that shows the current measurement value (depending on the set evaluation mode).

The left numeric display field shows the current measurement value in pixels, whereas the middle big display field shows the measurement value converted into millimeters.

Besides, the upper and lower tolerance limits are displayed.



RUN button:

After a click on the RUN button, the current measurement data will be transferred from the L-LAS-RL sensor to the PC via the serial interface in „scroll mode“.



In the form of a red curve the measurement values pass through the graphic display window from the right to the left.

The division of the y-axis corresponds with the pixels of the CCD line, or with the virtual number of sub-pixels of the line. In the graphic display the current measurement value (M-VALUE=982) is shown at the right end at the x-value of 100.

The current setpoint value (TEACH value) is shown as a broken horizontal line.

In addition, the current tolerance window is represented by two horizontal green lines that are applied symmetrically around the setpoint value.

In "RUN mode" the length of the data frame is limited to 18 words (36 bytes), which allows faster updating of the numeric and graphic display elements.

Compared to "DATA mode", data transfer through the serial RS232 interface therefore does not take so much time (in DATA mode the intensity information for every pixel must be transferred).

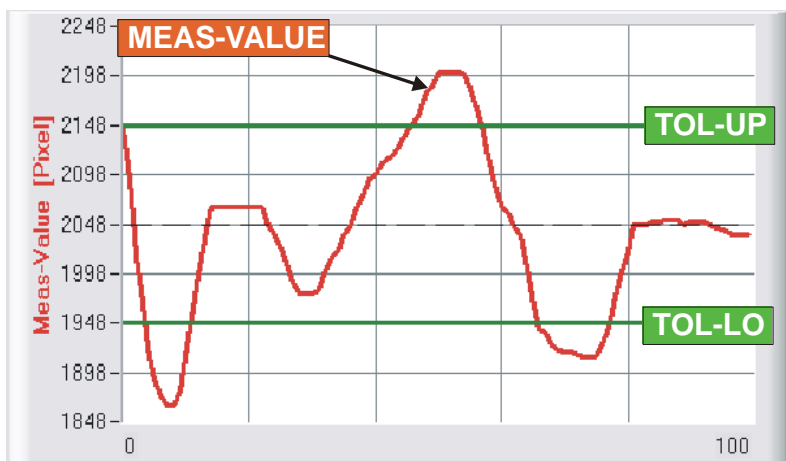

ZOOM

A click on the ZOOM button automatically rescales the y-axis of the graphic window, which provides a clearer display of measurement value changes.

The picture on the left shows the time characteristic of the measurement value changes as a red curve, and the tolerance band as two green lines. The teach value is shown as a broken horizontal line.

3.3 Serial RS232 data transfer:

RS232 COMMUNICATION:

- Standard RS232 serial interface without hardware-handshake.
- 3-line-connection: GND, TXD, RXD.
- Speed: Adjustable from 9600 Baud up to 115200 Baud, 8 data bits, no parity bit, 1 stop bit in binary mode, MSB first.



The stable function of the RS232 interface (status message after program start) is a basic prerequisite for data transfer between the PC and the *L-LAS-RL sensor*. Due to the low data transfer rate of the serial RS232 interface (19200 bit/s) only slow changes of the analog values can be observed in the graphic display at the PC. In order to guarantee the maximum switching frequency of the *L-LAS-RL sensor* it is therefore necessary to stop the data exchange during the normal monitoring process (click on the STOP button).

CONN:

When the software is started, it attempts to establish a connection to the *L-LAS-RL control unit* through the standard COM1 interface. If connection could be established successfully, the current firmware version is displayed in the status line.

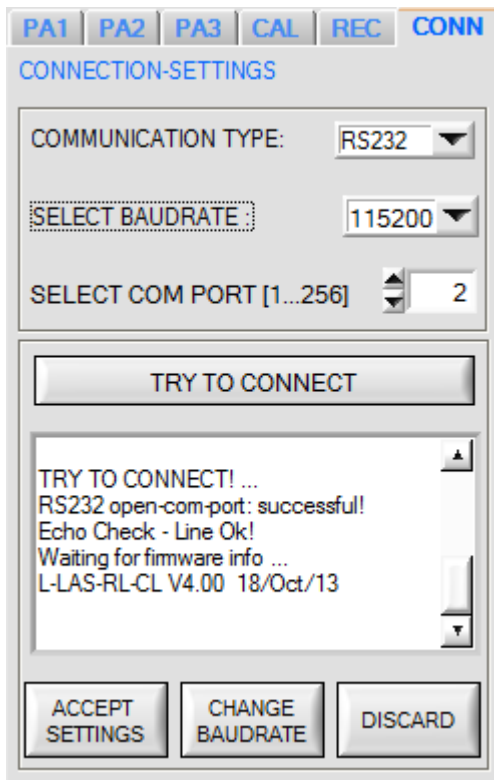

The serial connection between the PC and the *L-LAS-RL sensor* could not be established, or the connection is faulty.

In this case it should first be checked whether the *L-LAS-RL sensor* is connected to the power supply, and whether the serial interface cable is correctly connected to PC and control unit.

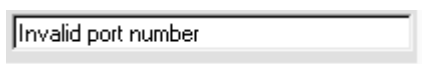

If there is an “Invalid port number” status message, the selected interface, e.g. COM2, is not available at your PC.



If there is a “Cannot open port” status message, the selected interface, e.g. COM2, may already be used by another device.

COMMUNICATION TYPE:

COMMUNICATION TYPE:

This function field is used to set the type of data communication:

RS232:

Data communication through the standard RS232 interface.

TCP/IP:

Data communication through a RS232-TCP/IP Ethernet converter module.

SELECT BAUDRATE:

SELECT BAUDRATE:

This function field is used to set the baud rate of the serial interface:

Possible values: 9600 Baud, 19200 Baud, 38400 Baud, 57600 Baud or 115200 Baud. (setting when delivered = 115200 Baud).

SELECT COM PORT [1...256]

SELECT COM PORT [1...256]:

This function field is used to set the number of the communication port. Possible values are COM 1 to 255.

The communication port number can be found in the Windows operating system under START/Control Panel/Device Manager.

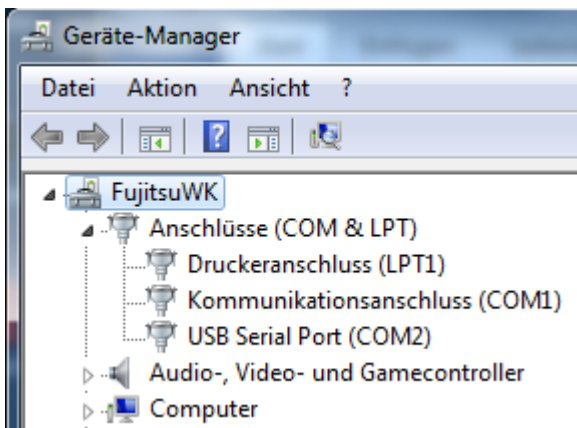

3.4 L-LAS-RL-Scope as an aid for sensor adjustment:



VIDEO:

After a click on the VIDEO button, the fine adjustment between the *L-LAS-RL transmitter unit and the receiver* can be observed in the graphic display window. Because of the limited data transfer rate of the RS232 interface the display window can only be updated every second.



STOP:

A mouse-click on the STOP button stops the data transfer between the *L-LAS-RL sensor* and the PC.

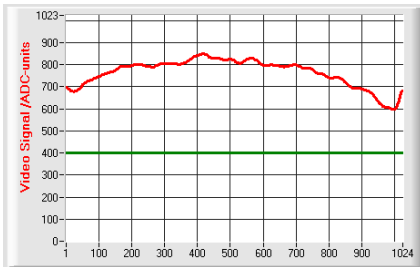

Optimal adjustment:

In the graphic display window the intensity profile is shown as a red curve. The numerical values 1 ... 1024 on the x-axis represent the individual pixels of the CCD line. The analog values of the CCD line are converted by way of an AD converter with 10-bit resolution, which results in a y-axis value range of 0 ... 1023.

As can be seen in the picture on the left, the CCD pixels 1 to 1024 are uniformly illuminated by the transmitter beam.

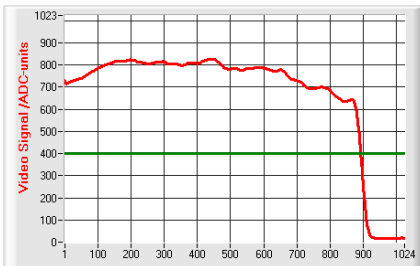

Wrong adjustment - right:

The transmitter beam no longer sufficiently illuminates the pixels at the right end of the CCD line. The red curve (intensity profile) in this part clearly is under the video threshold. The alignment of the laser transmitter unit or the CCD receiver unit must be readjusted in such a way that the pixels at the right end are illuminated again.

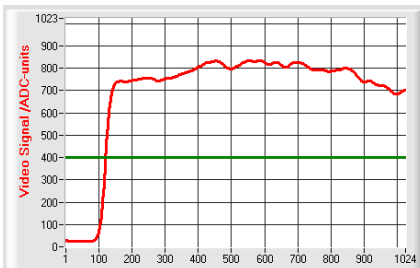

Wrong adjustment - left:

The transmitter beam no longer sufficiently illuminates the pixels at the left end of the CCD line. The alignment of the laser transmitter unit or the CCD receiver unit must be readjusted in such a way that the pixels at the left end are illuminated again.

3.5 L-LAS-RL-Scope as an aid for transmitter power adjustment:

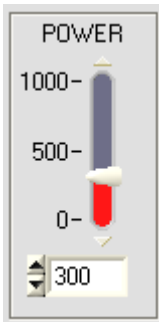

POWER:

In this field the laser power at the laser transmitter unit of the *L-LAS-RL sensor* can be set by using the slider or by entering a numerical value in the respective input field.



The laser power at the transmitter unit of the *L-LAS-RL sensor* is only updated when the SEND button is pressed.



VIDEO:

After a click on the VIDEO button, the current intensity profile is transferred from the *L-LAS-RL sensor* to the PC and is shown in the graphic display window. When the VIDEO function is active, the sensor's laser power can be changed (press the SEND button), and the effect of such a change can be observed in the intensity profile.

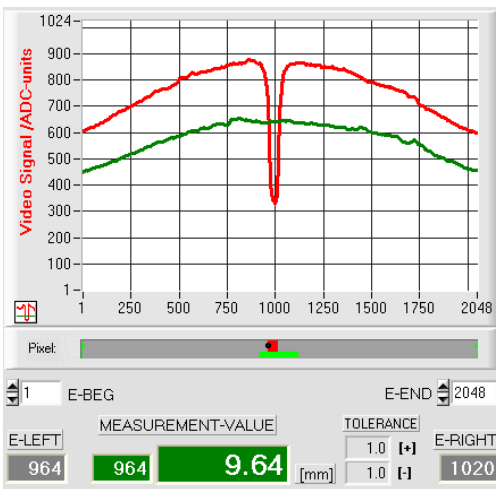

Optimal adjustment:

In the graphic display window the intensity profile is shown as a red curve. Through the complete CCD line the intensity profile lies above the video threshold (green line).

In the shadowed area (low reflection at the measurement object) the intensity profile lies below the green video threshold. (ADC-values < video threshold).

A meaningful measurement value can be derived from the intersection points of video threshold (green) and intensity profile (red).

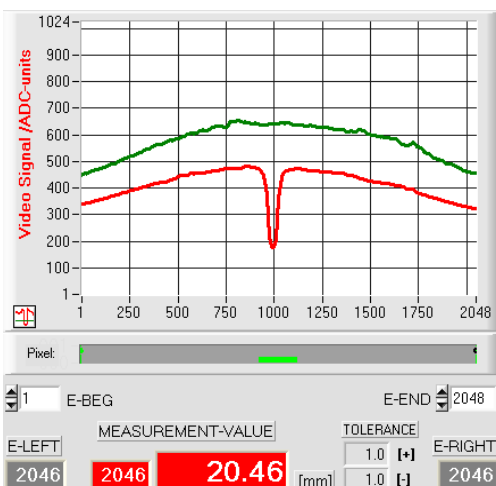

Transmitter power too low:

The intensity profile (red line) of the CCD line completely lies under the video threshold (green line).

The *L-LAS-RL sensor* does not detect any edges (bright/dark transitions, i.e. intersections between red curve and green video threshold) in the image of the beam.

Remedy:

Increase the laser power in steps, at the same time observing the intensity characteristic, until the red curve (intensity profile) from pixel 1 to pixel 2048 lies above the video threshold.

4 Evaluation modes

4.1 LEFT-EDGE



L-EDGE:

The first detected edge in the intensity profile of the CCD line is evaluated.

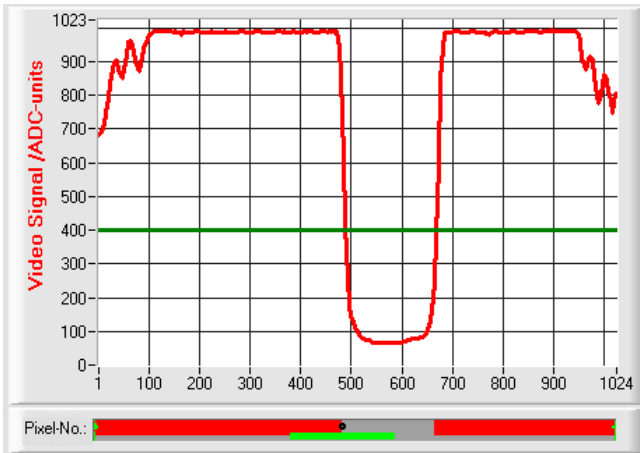

The criterion for edge detection is the transition between illuminated and shadowed areas in the intensity characteristic of the CCD line.

The one pixel of the CCD line at which this bright/dark transition takes place can be determined from the intersection between the video threshold (green horizontal line) and the intensity characteristic (red curve).

In the example picture on the left, the first bright/dark transition is detected at pixel no. 488.

The current measurement value M-VALUE = E-LEFT is shown in the red numeric display element.

4.2 RIGHT-EDGE



R-EDGE:

The second detected edge in the intensity profile of the CCD line is evaluated.



The one pixel of the CCD line at which the second bright/dark transition takes place can be determined from the intersection between the video threshold (green horizontal line) and the intensity characteristic (red curve).

In the example picture on the left, the second bright/dark transition is detected at pixel no. 668.

The black dot-shaped cursor beneath the graphic display window represents the current right edge (R-EDGE) of the shadowed area.

The current measurement value M-VALUE = E-RIGHT is shown in the red numeric display element.

4.3 WIDTH



WIDTH:

The difference between the second edge and the first edge in the intensity profile of the CCD line is evaluated.

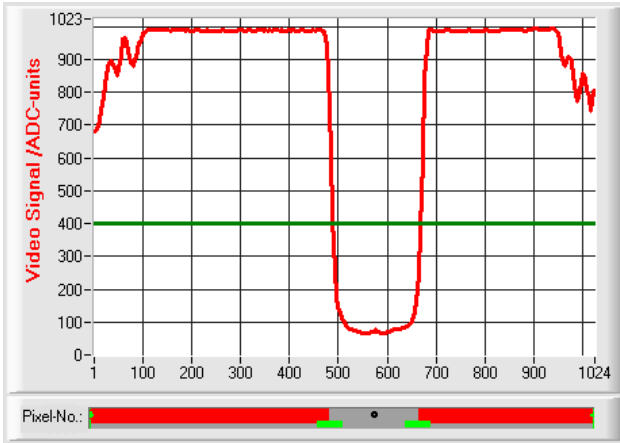

E-LEFT	E-BEG	TOL	52	M-VALUE	1	MAX	E-END	E-RIGHT
488	1	TEACH	180	180	1	MIN	1024	668

The two pixels where the bright/dark transition occurs can be determined from the two intersections between the video threshold (green horizontal line) and the intensity characteristic (red curve).

In the example picture on the left, the second bright/dark transition is detected at pixel no. 668, and the first bright/dark transition at pixel no. 488.

The difference is calculated as follows:

$$WIDTH = E_RIGHT - E_LEFT$$

The current measurement value M-VALUE = WIDTH is shown in the red numeric display element.

4.4 CENTER



CENTER:

The mean value of the first and the second edge is used as measurement value:
 $CENTER = (R-EDGE + L-EDGE) / 2$

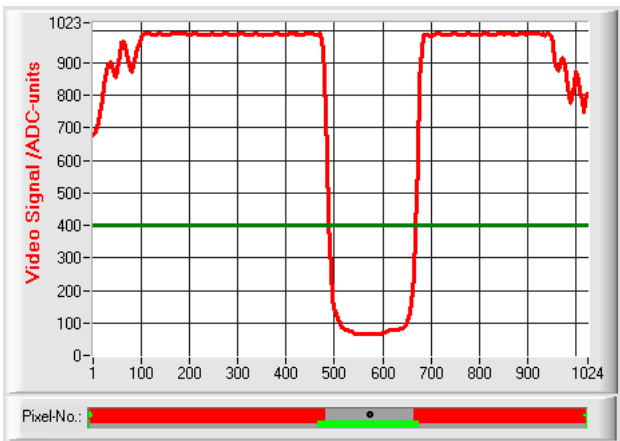

E-LEFT	E-BEG	TOL	104	M-VALUE	1	MAX	E-END	E-RIGHT
488	1	TEACH	576	576	1	MIN	1024	668

The two pixels where the bright/dark transition occurs can be determined from the two intersections between the video threshold (green horizontal line) and the intensity characteristic (red curve).

In the example picture on the left, the second bright/dark transition is detected at pixel no. 668, and the first bright/dark transition at pixel no. 488.

The mean value is calculated as follows:

$$CENTER = \frac{(E_RIGHT + E_LEFT)}{2}$$

The current measurement value M-VALUE = CENTER is shown in the red numeric display element.

5 Function of the data recorder

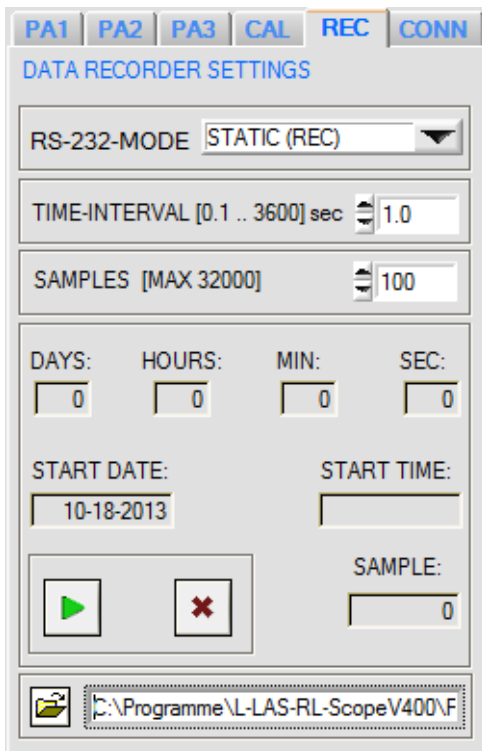

REC: DATA RECORDER:

A click on the REC button opens the DATA-RECORDER window on the user interface.

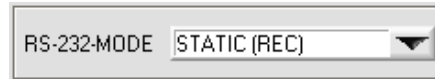

RS232-MODE:

Drop-down function field for setting the data request at the *L-LAS-RL Sensor* hardware.

STATIC(REC):

The sensor does not automatically send measurement data through the RS232 interface.

Every individual data transfer is started by the PC/PLC with command no. 18. Upon this request the sensor sends a single data frame (36 bytes) to the PC/PLC.

TRIG-IN0 L/H (REC):

A single data frame (36 bytes) is sent to the PC/PLC at every LOW/HIGH edge at digital input IN0/pin3/green.

TRIG-IN0 L/H (3-BYTE), CONTINUOUS (3-BYTE):

Cannot be used with the data recorder!

High-speed 3-BYTE data transfer -> see chapter 5.2.

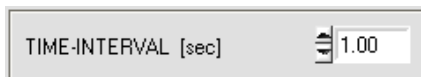

TIME-INTERVAL [sec]:

This numeric input field can be used to set a time interval in seconds. When this time interval is over the PC software automatically requests measurement data from the sensor (command 18). The PC/PLC waits until the complete data frame (36 byte) from the sensor has arrived in the input buffer of the serial interface of the PC. The PC then saves the new measurement data in an output file on the hard disk. Minimum value: 0.1 [sec]. When the TIME-INTERVAL [sec] is over the PC/PLC initiates a new transfer.



SAMPLES [MAX 32000]:

Numeric input field for setting the maximum number of measurement values that should be saved. The value range is from 10 to 32000.

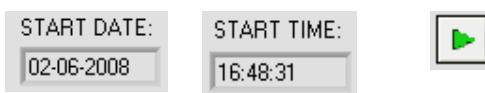

Numeric display fields providing information about the start date and start time. These displays are updated when the START button is pressed.

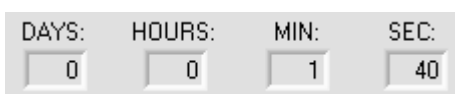

Numeric display elements showing the time interval in seconds that has passed since the recorder function was started.

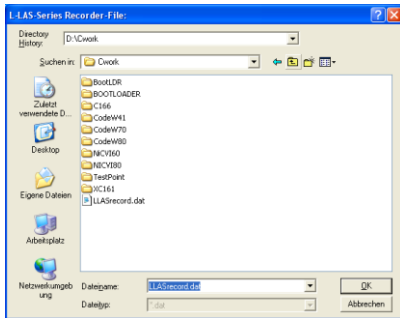

FILE button

A click on the FILE button opens a new dialog window for entering the file name and for setting the directory for the output file.

The currently selected directory and the file name of the output file are shown in a text display beside the FILE button.

d:\Programme\RECORD.DAT



START



STOP

Automatic recording can be started by pressing the START button. If recording should be stopped before the maximum number defined by SAMPLES is reached, this can be done by clicking on the STOP button.

5.1 Data format of the output file

The output file of the data recorder consists of 7 header lines, followed by the actual measurement data.

The measurement data are written to the output file line-by-line. Each line comprises 5 columns that are separated from each other by a TAB control character.

The output file can be opened with a simple text editor or a spreadsheet program (e.g. Microsoft EXCEL).

M-VALUE	E-LEFT	E-RIGHT	EDGES	M-VAL [um]
1019	1590	2609	6	4790
1021	1592	2616	6	4799
1016	1591	2608	6	4776
1013	1591	2605	6	4762
1014	1591	2605	6	4766
1014	1591	2605	6	4766
1015	1592	2608	6	4771
1014	1590	2604	6	4766
1016	1480	2496	6	4776
1017	1383	2400	6	4781
1017	1384	2401	6	4781
1018	1513	2531	6	4785
1016	1672	2688	4	4776
1015	1766	2784	4	4771
1010	1855	2865	6	4748
1009	1924	2936	4	4743
1006	1929	2936	4	4729
1006	2056	3064	6	4729
1005	2052	3057	4	4724
1004	2124	3128	4	4719
1008	2156	3168	4	4738
1008	1796	2804	4	4738
1011	1688	2699	4	4752
1013	1632	2645	8	4762
1015	1608	2624	6	4771
1016	1606	2624	4	4776
1017	1605	2622	6	4781
1021	1608	2632	6	4799

1. column = Measurement value (pixel) M-VALUE
2. column = Measurement value (pixel) E-LEFT
3. column = Measurement value (pixel) E-RIGHT
4. column = Number of EDGES
5. column = Measurement value (micrometer) M-VAL [um]

5.2 3-Byte RS232 data transfer

Fast data transfer of digital values (pixel values) from the *L-LAS-RL sensor* to the PLC can be realised by way of two RS232-MODE (3-byte) operating modes. With a baud rate of 19200 kBit/s the transfer of a 3-byte data frame takes approx. 1.0ms, with 115.2 kBit/s data exchanged takes approx. 0.2ms.

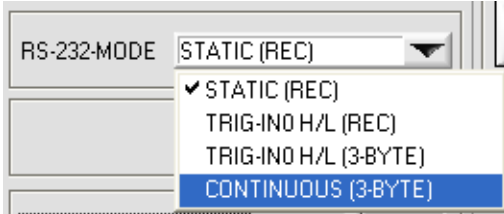

3-byte data transfer:

EXT-INO-L/H (3-Byte):

3-byte data transfer is triggered by a low/high or high/low edge (hardware specific) at IN0/pin3/green/ at the 8-pole PLC connector.

CONTINUOUS (3-Byte):

Continuous 3-byte data transfer during the main program run.

Setting of the RS232 interface:

- Standard RS232 serial interface, no hardware handshake
- 3-wire-connection: GND, TXD, RXD
- Speed: 9600 baud, 19200 baud, 38400 baud, 57600 baud or 115200 baud
- 8 data-bits, NO parity-bit, 1 stop-bit, binary-mode.

Transmission format of 3-byte data transfer:

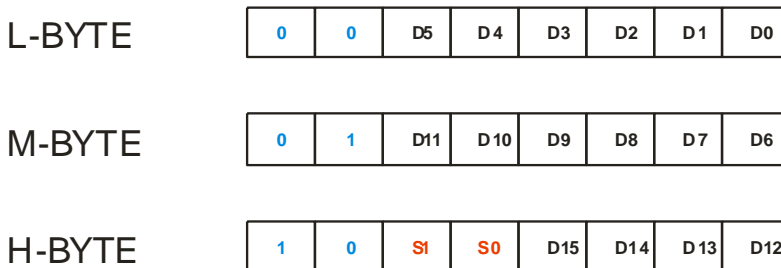
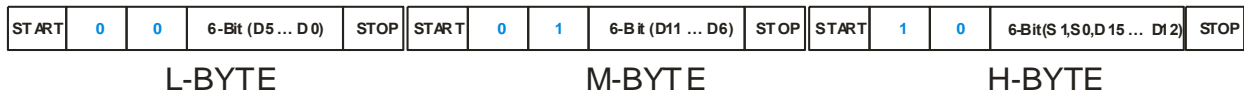

Extraction of the digital value (D0 – D15):

The first two bits are used for recognising the LOW-byte (0|0), Middle-byte (0|1) and High-byte (1|1). The High-byte also transfers two status bits (S1|S0).

Digital value DW = D0 ... D15

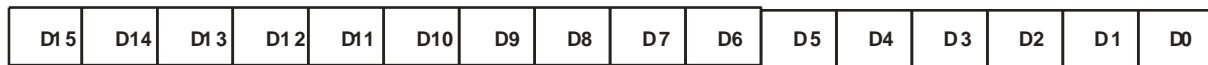

Conversion of digital value into mm – value:

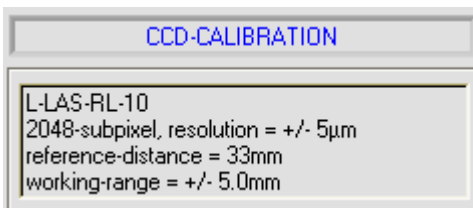

The millimetre value can be determined from the digital value and the pixel pitch. The pixel pitch is sensor-specific.

Example: *L-LAS-RL-10* with 0.5µm pixel pitch:
Measurement value [mm] = DW * 0.005mm

Examples for the extraction of the digital value:

Output of a typical hyperterminal program – The object is placed at two different positions in the operating range:

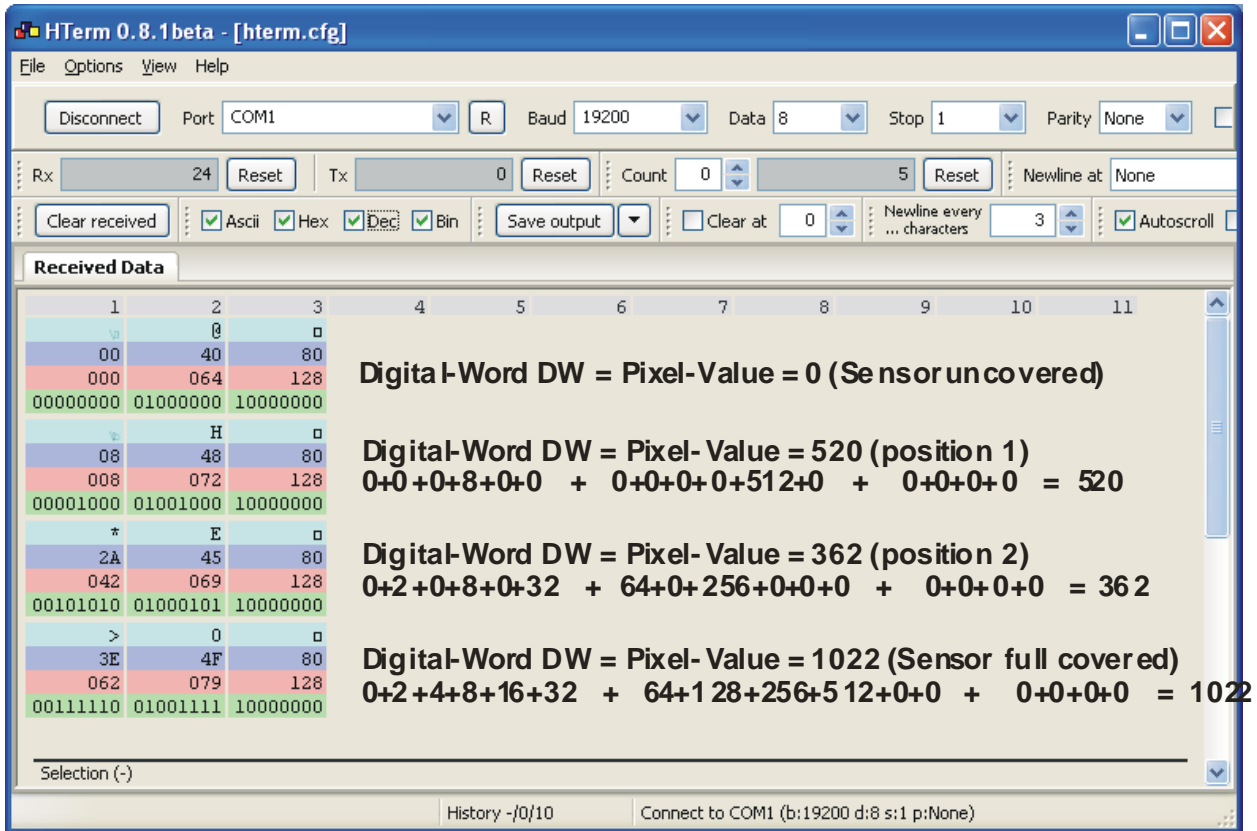

The screenshot shows the HTerm 0.8.1beta interface with the following configuration: Port COM1, Baud 19200, Data 8, Stop 1, Parity None. The received data is displayed in a table with columns 1-11. The data is interpreted as follows:

1	2	3	4	5	6	7	8	9	10	11
00	40	80								
000	064	128								
00000000	01000000	10000000								
08	48	80								
008	072	128								
00001000	01001000	10000000								
2A	45	80								
042	069	128								
00101010	01000101	10000000								
3E	4F	80								
062	079	128								
00111110	01001111	10000000								

Digital-Word DW = Pixel-Value = 0 (Sensor uncovered)

Digital-Word DW = Pixel-Value = 520 (position 1)
 $0+0+0+8+0+0 + 0+0+0+0+512+0 + 0+0+0+0 = 520$

Digital-Word DW = Pixel-Value = 362 (position 2)
 $0+2+0+8+0+32 + 64+0+256+0+0+0 + 0+0+0+0 = 362$

Digital-Word DW = Pixel-Value = 1022 (Sensor full covered)
 $0+2+4+8+16+32 + 64+128+256+512+0+0 + 0+0+0+0 = 1022$

6 CCD Calibration

PAR1
PAR2
CAL
REC
CONN

CALIBRATION SETTINGS

----- L-LAS-RL-20-CL -----
 resolution= +/- 20µm
 reference-distance= 55mm +/-5mm
 measuring-range= 20mm

CCD-OP-MODE NORMAL SPEED

ACTIVATE OBJECT CALIBRATION

OBJECT-DIM

PIXEL

10000 [µm]

0

Accept

Discard

SLOPE-VALUE [µm/pixel]

4.500

4.500

Save

CCD-CALIBRATION:

A click on the CAL button opens the CCD-CALIBRATION window.

EVAL-MODE: WIDTH

The problem with width measurement in reflected-light operation is that with identical reflectance of the measurement object surface the width measurement value largely depends on the set video threshold and the respective set transmitter power.



For fine calibration, width calibration can be activated for the measurement object with known object dimensions (e.g. 4.8mm):

ACTIVATE OBJECT CALIBRATION

OBJECT-DIM

PIXEL

4800 [µm]

1022

Accept

Enter the true width value (e.g.: 4800µm) in the edit field, then click on the Accept button.

Discard

SLOPE-VALUE [µm/pixel]

4.701

4.701

Save

The measurement object has a diameter of 4.80mm, but the measurement value only is 4.65 mm.

Accept

With a click on the Accept button the SLOPE-VALUE (in this example 4.701µm/pixel) is automatically calculated from the known measurement object width and the measured pixel value (1022).



After a click on the Save button the width of the measurement object is displayed correctly with the newly determined SLOPE-WIDTH value (4.80mm).

SAVE

ACTIVATE OBJECT CALIBRATION

OBJECT-DIM PIXEL

4800 [µm] 1022 Accept

Discard

SLOPE-VALUE [µm/pixel]

4.701 4.701 Save



Attention !

A click on the SAVE button only saves the new calibration data to the volatile RAM memory!
To save them permanently, click on SEND + EEPROM!

Discard

Click on the Discard button to cancel fine calibration without saving the calibration values.

Manual input of calibration data:

SLOPE-VALUE [µm/pixel]

4.800 4.800 Save

←

The calibration data also can be modified manually at the control unit of the sensor.

When the CAL pop-up window has been opened, the numerical values can at any time be changed manually in the corresponding numerical input fields, without having to go through the calibration procedure.

Save

The newly entered calibration values must first be activated at the control unit by clicking on the Save button.

7 Annex

7.1 Function of the TEACH/RESET button

The housing of the *L-LAS-RL sensor* features a pushbutton with two functions:

L-LAS-RL-CON1, L-LAS-RL-150-... or L-LAS-RL-CAM-... types:

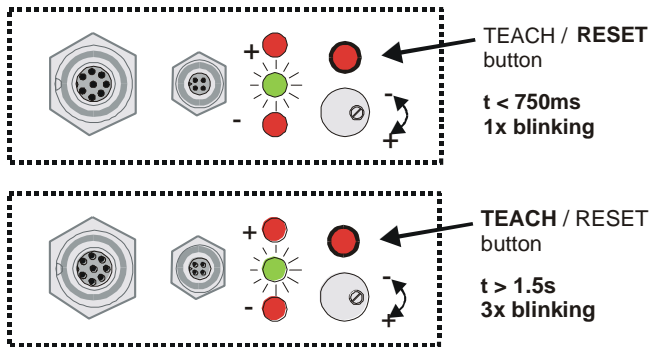

RESET function:

When the button is pressed for a short time ($t < 750\text{ms}$), the current maximum and minimum values are reset.

A hardware/software RESET is not performed!

TEACH function:

When the button is pressed for a longer time ($t > 1.5\text{s}$), the current edge coverings are stored as teach value in the RAM memory. When the teach process has been performed successfully, the green LED blinks three times.

L-LAS-RL-... (M34) types:

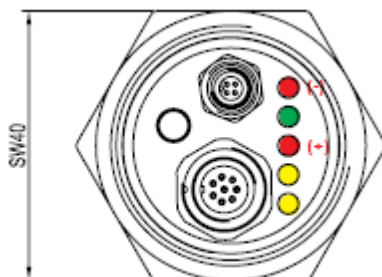

With sensors of type L-LAS-RL-... (M34) the teach/reset function can be activated by pressing the button at the housing.

Reset: Press shortly -> LED/yellow blinks 1x
 Teach: Press long -> LED/yellow blinks 3x

L-LAS-RL-...-CL types:

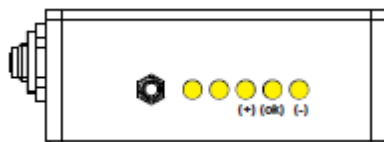

With sensors of type L-LAS-RL-...-CL the teach/reset function can be activated by pressing the button at the housing.

Reset: Press shortly -> LED/yellow blinks 1x
 Teach: Press long -> LED/yellow blinks 3x

7.2 Function of the tolerance potentiometer

The housing of the *L-LAS-RL sensor* features a potentiometer for setting the tolerance band width [1].

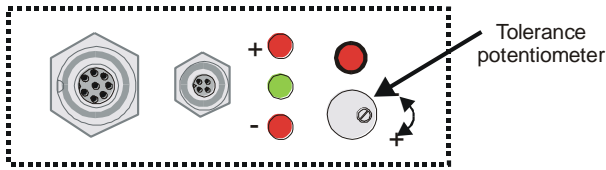

TOLERANCE potentiometer:

Turning the potentiometer clockwise increases the tolerance band width.

Turning it counter-clockwise decreases the tolerance band width.



The potentiometer must be activated (switch position **ENABLE ALL** or **ENABLE TOL SET**) in order to use it for setting the tolerance band width at the *L-LAS-RL sensor*.

[1] not available with L-LAS-RL-... (M34) types and L-LAS-RL-...-CL types

7.3 Function of digital inputs IN0 and IN1

The *L-LAS-RL sensor* has two digital inputs IN0 and IN1 [1] that can be contacted through the 8-pole female connector (type Binder 712).

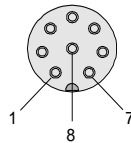
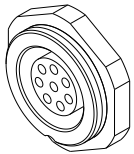

L-LAS-RL-CON1 L-LAS-RL-150-... L-LAS-CAM-... L-LAS-RL-...-CL

Pin:	Color:	Assignment:
1	white	0V (GND)
2	brown	+24VDC +/- 10% (U _b)
3	green	IN0 (EXT TRIGGER)
4	yellow	IN1 (TEACH/RESET)
5	gray	OUT0 (-)
6	pink	OUT1 (+)
7	blue	OUT2 (OK)
8	red	ANALOG (0...+10V)

[1] IN1 not available with L-LAS-RL-... (M34) types:

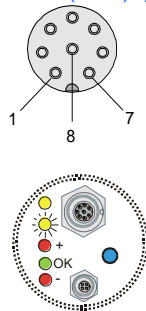
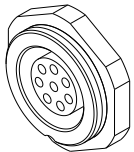

L-LAS-RL-... (M34)

Pin:	Color:	Assignment:
1	white	0V (GND)
2	brown	+24VDC +/- 10% (U _b)
3	green	IN0 (EXT TRIGGER)
4	yellow	OUT0 (-)
5	gray	OUT1 (+)
6	pink	OUT2 (OK)
7	blue	I-OUT (4/20mA)
8	red	ANALOG (0...+10V)

DIGITAL INPUT IN0 (pin3/green) EXT-TRIGGER:

The function of digital input IN0/pin3/green depends on the operating mode that is set in the EXT-IN0-MODE function field:

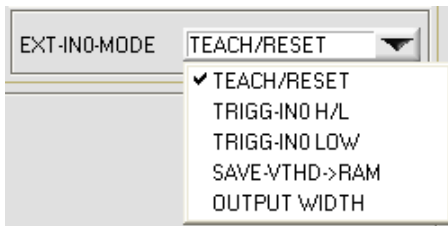

EXT-IN0-MODE:

TEACH/RESET (only for type L-LAS-RL-... (M34)):

Reset of maximum values by a pulse of duration $t < 750\text{ms}$.
Teach function at the sensor by a pulse of duration $t > 1.5\text{s}$.

TRIGG-IN0 H/L (for type L-LAS-RL-... (M34) or L/H:

External edge-controlled triggering of measurement value evaluation through digital input IN0/pin3/green.

TRIGG-IN0 LOW (for type L-LAS-RL-... (M34)) or HIGH:

External triggering of measurement value evaluation through a high level (+Ub) at digital input IN0/pin3/green.

SAVE-VTHD ->RAM:

Saving of the follow-up video threshold to the volatile RAM memory upon an edge change at digital input IN0/pin3/green.

OUTPUT WIDTH:

Output of width information upon a level change at input IN0.

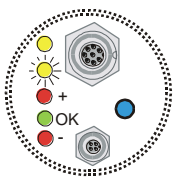
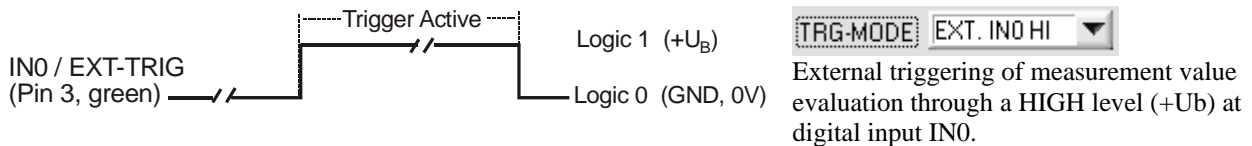
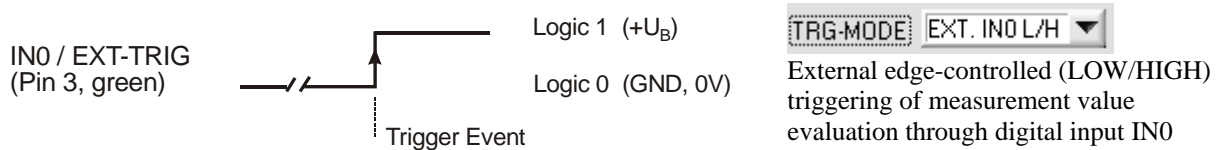

With sensor type L-LAS-RL-... (M-34) digital input IN0/pin3/green is

LOW-ACTIVE!

This means that a level change from HIGH/LOW triggers the respective function!

DIGITAL INPUT IN1 (Pin4/yellow) TEACH/RESET:

RESET function:

When a HIGH pulse of less than **750 ms** duration is applied, the RESET function is performed at the *L-LAS-RL sensor*. This resets the current maximum and minimum values (drag pointer). A hardware/software RESET is not performed! When a RESET pulse is detected, the yellow LED flashes shortly one time.

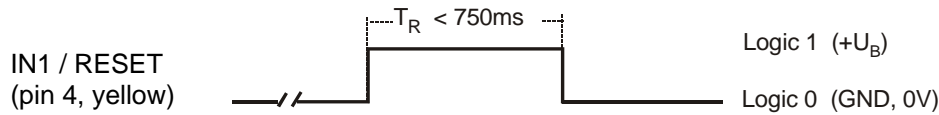

TEACH function:

When a HIGH pulse of more than **1.5s** duration is applied, the TEACH function is performed at the *L-LAS-RL sensor*. When a TEACH pulse is detected, the green LED at the housing flashes shortly three times.

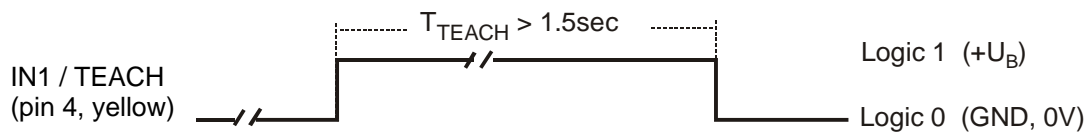

7.4 Connector assignment

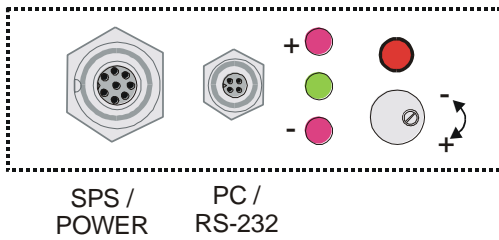

L-LAS-RL-CON1, L-LAS-RL-150-..., L-LAS-CAM-... types

At the housing of the *L-LAS-RL* sensor there is a female connector for power supply connection (8-pol. type Binder 712) and a second female connector for connecting a serial RS232 connecting cable (4-pol. type Binder 707).

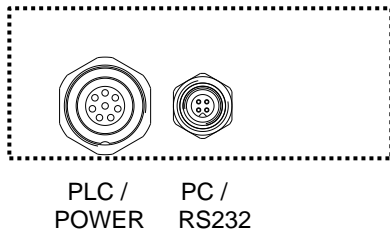

L-LAS-RL-...-CL types

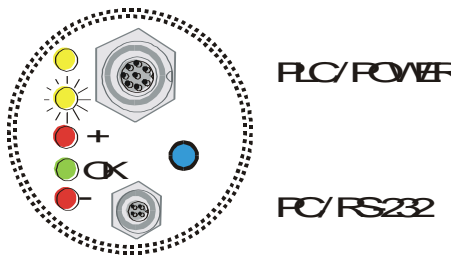

L-LAS-RL-... (M-34) types

RS232 connection to the PC:

4-pole M5 female connector type Binder 707

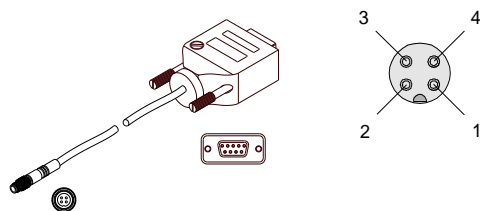

Pin:	Assignment:
1	+Ub
2	0V (GND)
3	RxD
4	TxD

Connecting cable:

cab-las4/PC (length 2m, cable jacket: PUR)

Interface to PLC/voltage supply:

8-pole female connector type Binder 712

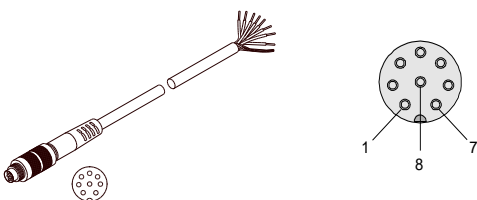

Pin:	Color:	Assignment:	Assignment L-LAS-RL-... (M34):
1	white	0V (GND)	0V (GND)
2	brown	+24VDC	+24 VDC
3	green	IN0	IN0
4	yellow	IN1	OUT0 (-)
5	grey	OUT0 (-)	OUT1 (+)
6	pink	OUT1 (+)	OUT2 (OK)
7	blue	OUT2 (OK)	I-OUT (4 .. 20mA)
8	red	Analog (0... 10V)	Analog (0 ... 10V)

Connecting cable:

cab-las8/SPS (length 2m, cable jacket: PUR)

7.5 Alignment of the CCD line / Visualisation LED

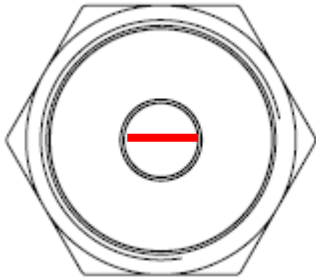

L-LAS-RL-... (M34) types:

The housing of the *L-LAS-RL-...* (M34) sensors features an LED row comprising 5 light-emitting diodes.

The CCD line  is installed in the receiver optics unit in parallel to the visualisation LED row!

Function of the visualisation LED row

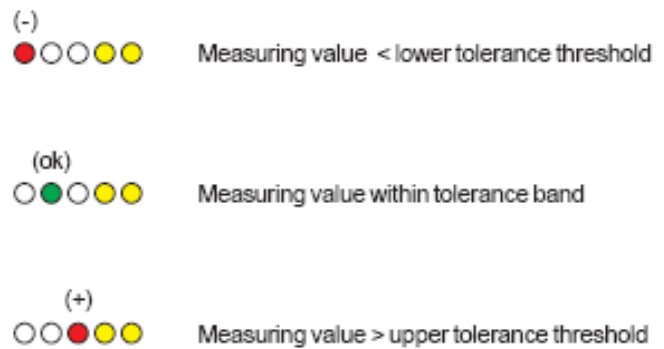
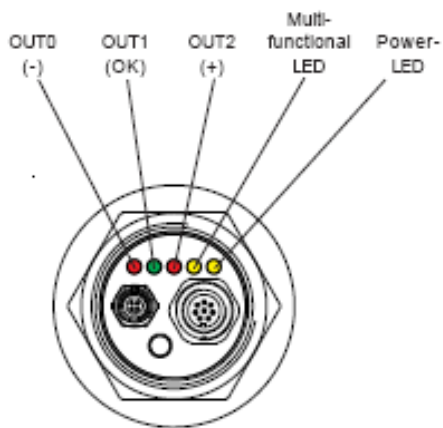

The switching state that is indicated at the LED display also is applied at the digital outputs OUT0, OUT1 and OUT2.

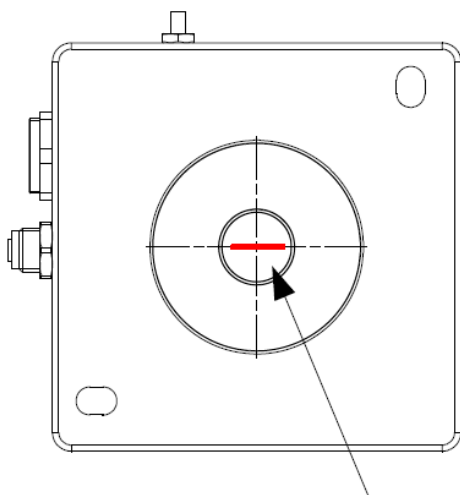

Alignment of the line detector

L-LAS-RL-...-CL types:

The CCD line  is installed lengthwise in the direction of the cable connections.

7.6 RS232 interface protocol

- Standard RS232 serial interface, no hardware handshake
- 3-wire-connection: GND, TXD, RXD
- Speed: 9600 Baud, 19200 Baud, 38400 Baud, 57600 Baud or 115200 Baud
- 8 data-bits
- NO parity-bit
- 1 STOP-bit
- Binary-data mode.

METHOD:

The sensor control unit always behaves passively. Data exchange therefore is initiated by the PC (or PLC). The PC sends a data package ("frame") either with or without appended data, to which the sensor control unit responds with a frame that matches the request. The data package consists of a **"HEADER"** and the optional **appended "DATA"**.

HEADER

- 1. Byte** : Synchronisation byte <SYNC> (85_{dec} = 0x55_{hex})
- 2. Byte** : Order byte <ORDER>
3. Byte : Argument <ARG LO>
4. Byte : Argument <ARG HI>
5. Byte : Data length <LEN LO>
6. Byte : Data length <LEN HI>
7. Byte : Checksum Header <CRC8 HEAD>
8. Byte : Checksum Data <CRC8 DATA>

The first byte is a synchronisation byte and always is 85_{dec} (55_{hex}). The second byte is the so-called order byte <ORDER> which determines the action that should be performed (send data, save data, etc.). A 16-bit value <ARG> follows as the third and fourth byte. Depending on the order the argument is assigned a corresponding value. The fifth and sixth byte again form a 16-bit value <LEN> which specifies the number of appended data bytes. If no data are appended, <LEN=0>. The maximum data length is 512 bytes <LEN=512>. The seventh byte is formed with the CRC8 checksum over all data bytes. The eighth byte is the CRC8 checksum over the header and is formed over bytes 1 up to and incl. 7. The header always has a total length of 8 bytes. The complete frame may contain between 8 and 520 bytes.

Byte1 Header	Byte2 Header	Byte3 Header	Byte4 Header	Byte5 Header	Byte6 Header	Byte7 Header	Byte8 Header	Byte9 Data	Byte10 Data	...	Byte n+7 Data	Byte n+8 Data
0x55	<ORDER>	<ARG> (lo byte)	<ARG> (hi byte)	<LEN> (lo byte)	<LEN> (hi byte)	CRC8 (Data)	CRC8 (Header)	Data1 (lo byte)	Data1 (hi byte)	...	Data n/2 (lo byte)	Data n/2 (hi byte)

<ORDER>	Meaning of the 2.nd byte <order>:	ORDER-TABLE
0	NOP	no operation
1	Send parameter from PC to L-LAS-RAM	PC ⇒ L-LAS-RAM
2	Get parameter from L-LAS-RAM	L-LAS-RAM ⇒ PC
3	Send parameter from PC to EEPROM	PC ⇒ L-LAS-EEPROM
4	Get parameter from EEPROM of L-LAS	L-LAS-EEPROM ⇒ PC
5	Echo check: Get echo of L-LAS	first word=0x00AA=170 _{dec}
6	Activate teach at L-LAS, store in RAM	PC ⇒ L-LAS-RAM
7	Get software version info of L-LAS	L-LAS ⇒ PC
8	Get measured values from L-LAS-RAM	L-LAS-RAM ⇒ PC
9	Get video-buffer info from L-LAS	L-LAS-RAM ⇒ PC
11	Reset maximum/minimum values at analog-output	PC ⇒ L-LAS-RAM
13	Refresh auto-video-threshold to RAM or EEPROM	PC ⇒ L-LAS-RAM
18	Get measured values from L-LAS-RAM (data-recorder)	PC ⇒ L-LAS-RAM
190	Change RS232-baud-rate (L-LAS-RAM)	PC ⇒ L-LAS-RAM

CRC8 checksum

The so-called "Cyclic Redundancy Check" or CRC is used to verify data integrity. This algorithm makes it possible to detect individual bit errors, missing bytes, and faulty frames. For this purpose a value - the so-called checksum - is calculated over the data (bytes) to be checked and is transmitted together with the data package. Calculation is performed according to an exactly specified method based on a generator polynomial. The length of the checksum is 8 bit (= 1 byte). The generator polynomial is:

$$X^8+X^5+X^4+X^0$$

To verify the data after they have been received, CRC calculation is performed once again. If the sent and the newly calculated CRC values are identical, the data are without error.

The following pseudo code can be used for checksum calculation:

```

calcCRC8 (data[ ], table[ ])
Input: data[ ], n data of unsigned 8bit
         table[ ], 256 table entries of unsigned 8bit
Output: crc8, unsigned 8bit

crc8 := AAhex
for I := 1 to n do
    idx := crc8 EXOR data[ i ]
    crc8 := table[ idx ]
endfor
return crc8
    
```

table[]

0	94	188	226	97	63	221	131	194	156	126	32	163	253	31	65
157	195	33	127	252	162	64	30	95	1	227	189	62	96	130	220
35	125	159	193	66	28	254	160	225	191	93	3	128	222	60	98
190	224	2	92	223	129	99	61	124	34	192	158	29	67	161	255
70	24	250	164	39	121	155	197	132	218	56	102	229	187	89	7
219	133	103	57	186	228	6	88	25	71	165	251	120	38	196	154
101	59	217	135	4	90	184	230	167	249	27	69	198	152	122	36
248	166	68	26	153	199	37	123	58	100	134	216	91	5	231	185
140	210	48	110	237	179	81	15	78	16	242	172	47	113	147	205
17	79	173	243	112	46	204	146	211	141	111	49	178	236	14	80
175	241	19	77	206	144	114	44	109	51	209	143	12	82	176	238
50	108	142	208	83	13	239	177	240	174	76	18	145	207	45	115
202	148	118	40	171	245	23	73	8	86	180	234	105	55	213	139
87	9	235	181	54	104	138	212	149	203	41	119	244	170	72	22
233	183	85	11	136	214	52	106	43	117	151	201	74	20	246	168
116	42	200	150	21	75	169	247	182	232	10	84	215	137	107	53

Appended data: Parameter set

The sensors of type L-LAS-RL operate with the following parameters, which in the appended data are sent to the sensor or read from the sensor in the stated sequence:

DATA-FRAME: <parameter-set>		
Para	Meaning	Comment
1	POWER	Laser intensity (0 ... 1000)
2	POWER-MODE	Laser power mode: (0 = STATIC), (1=DYNAMIC)
3	BACKGND-MODE	Background mode (0=OFF, 1=ON)
4	POLARITY	Polarity setting for OUT0,OUT1,OUT2 (0=DIRECT, 1=INVERSE)
5	EVAL-MOD	Evaluation mode (0=L-EDGE, 1=R-EDGE, 2=WIDTH, 3=CENTER)
6	E-BEG	Evaluation start-pixel (1 ... E_END - 1)
7	E-END	Evaluation end -pixel (E_BEG+1 ... SUBPIXEL)
8	TEACH-VALUE	Teach-value (1 ... SUBPIXEL)
9	TOLERANCE-HI-VALUE	Upper-tolerance (0 ... SUBPIXEL/2)
10	TOLERANCE-LO-VALUE	Lower-tolerance (0 ... SUBPIXEL/2)
11	AVERAGE	Average-setting (1,2,4,5,16,32,64,128 or 256)
12	EX-TRIGG-MODE	External-trigger-mode:(0=CONTINUOUS, 1=IN0 L/H, 2=IN0 HI, 3=SAVE-VTHD, 4=OUTPUT-WIDTH, 5=LIGHT-ON)
13	ANA-MODE	Analog-mode (0=DIRECT,1=MAXIMA,2=MINIMA,3=MAX_MIN)
14	OP-MODE	CCD-operation-mode (0=FULL_RES, 1=HALF_RES)
15	HW-MODE	Enable/disable TOL-potentiometer and button at housing (DISABLE-ALL=0, ENABLE-ALL=1,ENABLE-BTN=2, ENABLE POTI=3)
16	VTHDMODE	Video-threshold-mode: (0=FIX, 1=AUTO)
17	VTHD-FIX	Video-threshold-fix: (0 ... 100) percent of full ADC-range
18	VTHD-AUTO	Video-threshold-auto: (0 ... 100) percent of full ADC-range
19	RS232-MODE	RS232 mode: (0=STAT,1=IN0-L/H,2=IN0-HI[3-byte],3=CONT[3-byte])
20	RS232-BAUDRATE	Baudrate: (0=9600,1=19200,2=38400,3=57600,4=115200) baud
21	SMOOTH	Smooth-video signal (1,2,4,6,8,12,24,32,48 or 64) pixel
22	ANA-ZOOM	Analog-output-zoom-mode: output (0=DIRECT, 1=ZOOMx1, 2=ZOOMx2, 3=ZOOMx4, 4=ZOOMx8, 5=ZOOMx16, 6=WIN_5V, 7=WIN_10V)
23	INT-TRIGG-MODE	Internal-trigger-mode: (0=DISABLE, 1=DARK-PIX, 2=LIGHT-PIX)
24	TRIGG-PIXEL	Trigger-pixel: (1 ... SUBPIXEL) threshold for internal trigger
25	OUT-MODE	Output-mode (0=U-OUT:0..10V, 1=I-OUT: 4..20mA)
26	INT-TIME	Exposure-time [ms], (1,2,3,... 20)
27	FREE-USE	Free-use
28	UM-SLOPE	[32-bit] Slope-value for width-calibration (x1024)

RS232 data transfer examples:

< ORDER = 5 > : READ CONNECTION OK from sensor.

DATA FRAME PC → Sensor

Byte1 Header	Byte2 Header	Byte3 Header	Byte4 Header	Byte5 Header	Byte6 Header	Byte7 Header	Byte8 Header
0x55	<order>	<ARG> (lo byte)	<ARG> (hi byte)	<LEN> (lo byte)	<LEN> (hi byte)	CRC8 (Data)	CRC8 (Header)
85	5	0	0	0	0	170	60
ARG=0				LEN=0			

DATA FRAME Sensor → PC

Byte1 Header	Byte2 Header	Byte3 Header	Byte4 Header	Byte5 Header	Byte6 Header	Byte7 Header	Byte8 Header
0x55	<order>	<ARG> (lo byte)	<ARG> (hi byte)	<LEN> (lo byte)	<LEN> (hi byte)	CRC8 (Data)	CRC8 (Header)
85	5	170	0	0	0	170	178
ARG=170				LEN=0			

< ORDER = 7 > : Read FIRMWARE-STRING from sensor.

Byte1 Header	Byte2 Header	Byte3 Header	Byte4 Header	Byte5 Header	Byte6 Header	Byte7 Header	Byte8 Header
0x55	<order>	<ARG> (lo byte)	<ARG> (hi byte)	<LEN> (lo byte)	<LEN> (hi byte)	CRC8 (Data)	CRC8 (Header)
85 (dec)	7	0	0	0	0	170	82
ARG=0				LEN=0			

DATA FRAME Sensor → PC

Byte1 Header	Byte2 Header	Byte3 Header	Byte4 Header	Byte5 Header	Byte6 Header	Byte7 Header	Byte8 Header	Byte9 Data	Byte10 Data	Byte11 Data	Byte12 Data
0x55	<order>	<ARG> (lo byte)	<ARG> (hi byte)	<LEN> (lo byte)	<LEN> (hi byte)	CRC8 (Data)	CRC8 (Header)	ASCII	ASCII	ASCII	ASCII
85 (dec)	7	0	0	72	0	183	38	F	I	R	M
ARG=0				LEN=72							
Byte13 Data	Byte14 Data	Byte15 Data	Byte16 Data	Byte17 Data	Byte18 Data	Byte19 Data	Byte20 Data	Byte21 Data	Byte22 Data	Byte23 Data	Byte24 Data
ASCII	ASCII	ASCII	ASCII	ASCII	ASCII	ASCII	ASCII	ASCII	ASCII	ASCII	ASCII
W	A	R	E		S	T	R	I	N	G	
Byte25 Data	Byte26 Data	Byte27 Data	Byte28 Data	Byte29 Data	Byte30 Data	Byte31 Data	Byte32 Data	Byte33 Data	Byte34 Data	Byte35 Data	Byte36 Data
ASCII	ASCII	ASCII	ASCII	ASCII	ASCII	ASCII	ASCII	ASCII	ASCII	ASCII	ASCII
											R
Byte37 Data	Byte38 Data	Byte39 Data	Byte40 Data	Byte41 Data	Byte42 Data	Byte43 Data	Byte44 Data	Byte45 Data	Byte46 Data	Byte47 Data	Byte48 Data
ASCII	ASCII	ASCII	ASCII	ASCII	ASCII	ASCII	ASCII	ASCII	ASCII	ASCII	ASCII
T	:	K	W	x	x	/	x	x			
Byte49 Data	Byte50 Data	Byte51 Data	Byte52 Data	Byte53 Data	Byte54 Data	Byte55 Data	Byte56 Data	Byte57 Data	Byte58 Data	Byte59 Data	Byte60 Data
ASCII	ASCII	ASCII	ASCII	ASCII	ASCII	ASCII	ASCII	ASCII	ASCII	ASCII	ASCII
Byte61 Data	Byte62 Data	Byte63 Data	Byte64 Data	Byte65 Data	Byte66 Data	Byte67 Data	Byte68 Data	Byte69 Data	Byte70 Data	Byte71 Data	Byte72 Data
ASCII	ASCII	ASCII	ASCII	ASCII	ASCII	ASCII	ASCII	ASCII	ASCII	ASCII	ASCII
Byte73 Data	Byte74 Data	Byte75 Data	Byte76 Data	Byte77 Data	Byte78 Data	Byte79 Data	Byte80 Data	Byte81 Data	Byte82 Data		
ASCII	ASCII	ASCII	ASCII	ASCII	ASCII	ASCII	ASCII	ASCII	ASCII		

< ORDER = 1 > : SEND PARAMETER-SET TO RAM of the sensor

DATA FRAME PC → Sensor

Byte1 Header	Byte2 Header	Byte3 Header	Byte4 Header	Byte5 Header	Byte6 Header	Byte7 Header	Byte8 Header	Byte9 Data	Byte10 Data	Byte11 Data	Byte12 Data
0x55	<order>	<ARG> (lo byte)	<ARG> (hi byte)	<LEN> (lo byte)	<LEN> (hi byte)	CRC8 (Data)	CRC8 (Header)	Para1 (lo byte)	Para1 (hi byte)	Para2 (lo byte)	Para2 (hi byte)
85 (dec)	1	0	0	60	0	232	181	32	3	0	0
ARG=0				LEN=60				POWER=200		PMODE=0	

Byte13 Data	Byte14 Data	Byte15 Data	Byte16 Data	Byte17 Data	Byte18 Data	Byte19 Data	Byte20 Data	Byte21 Data	Byte22 Data	Byte23 Data	Byte24 Data
Para3 (lo byte)	Para3 (hi byte)	Para4 (lo byte)	Para4 (hi byte)	Para5 (lo byte)	Para5 (hi byte)	Para6 (lo byte)	Para6 (hi byte)	Para7 (lo byte)	Para7 (hi byte)	Para8 (lo byte)	Para8 (hi byte)
128	12	228	12	1	0	3	0	1	0	1	0
BGMODE=0		POLARITY=1		EMODE=0		EBEG=1		EEND=4096		TVAL=2048	

Byte25 Data	Byte26 Data	Byte27 Data	Byte28 Data	Byte29 Data	Byte30 Data	Byte31 Data	Byte32 Data	Byte33 Data	Byte34 Data	Byte35 Data	Byte36 Data
Para9 (lo byte)	Para9 (hi byte)	Para10 (lo byte)	Para10 (hi byte)	Para11 (lo byte)	Para11 (hi byte)	Para12 (lo byte)	Para12 (hi byte)	Para13 (lo byte)	Para13 (hi byte)	Para14 (lo byte)	Para14 (hi byte)
1	0	0	0	0	0	1	0	100	0	0	0
TOLLO=200		TOLHI=200		AVGERAGE=2		EXTRIGMODE=0		ANAMODE=0		OPMODE=0	

Byte37 Data	Byte38 Data	Byte39 Data	Byte40 Data	Byte41 Data	Byte42 Data	Byte43 Data	Byte44 Data	Byte45 Data	Byte46 Data	Byte47 Data	Byte48 Data
Para15 (lo byte)	Para15 (hi byte)	Para16 (lo byte)	Para16 (hi byte)	Para17 (lo byte)	Para17 (hi byte)	Para18 (lo byte)	Para18 (hi byte)	Para19 (lo byte)	Para19 (hi byte)	Para20 (lo byte)	Para20 (hi byte)
0	0	100	0	100	0	1	0	184	11	20	0
HWMODE=0		VTHDMODE=0		VTHDFIX=25		VTHDAUTO=70		RS232MODE=0		RS232BAUD=4	

Byte49 Data	Byte50 Data	Byte51 Data	Byte52 Data	Byte53 Data	Byte54 Data	Byte55 Data	Byte56 Data	Byte57 Data	Byte58 Data	Byte59 Data	Byte60 Data
Para21 (lo byte)	Para21 (hi byte)	Para22 (lo byte)	Para22 (hi byte)	Para23 (lo byte)	Para23 (hi byte)	Para24 (lo byte)	Para24 (hi byte)	Para25 (lo byte)	Para25 (hi byte)	Para26 (lo byte)	Para26 (hi byte)
0	0	100	0	100	0	1	0	184	11	20	0
SMOOTH=0		ANAZOOM=0		INTRIGMODE=0		TIRGPIX=10		OUTMODE=0		EX_TIME=1	

Byte61 Data	Byte62 Data	Byte63 Data	Byte64 Data	Byte65 Data	Byte66 Data	Byte67 Data	Byte68 Data
Para27 (lo byte)	Para27 (hi byte)	Para28 (lo byte)	Para28 (hi byte)	Para29 (lo byte)	Para29 (hi byte)	Para29 (lo byte)	Para29 (hi byte)
				10	0	0	0
TOLMODE		FREEPARA		UMSLOPE=4608			

DATA FRAME Sensor → PC

Byte1 Header	Byte2 Header	Byte3 Header	Byte4 Header	Byte5 Header	Byte6 Header	Byte7 Header	Byte8 Header
0x55	<order>	<ARG> (lo byte)	<ARG> (hi byte)	<LEN> (lo byte)	<LEN> (hi byte)	CRC8 (Data)	CRC8 (Header)
85 (dec)	1	0	0	0	0	170	224
ARG=0				LEN=0			

< ORDER = 2 > : READ PARAMETER-SET FROM RAM of the sensor

DATA FRAME PC → Sensor

Byte1 Header	Byte2 Header	Byte3 Header	Byte4 Header	Byte5 Header	Byte6 Header	Byte7 Header	Byte8 Header
0x55	<order>	<ARG> (lo byte)	<ARG> (hi byte)	<LEN> (lo byte)	<LEN> (hi byte)	CRC8 (Data)	CRC8 (Header)
85 (dec)	2	0	0	0	0	170	185
ARG=0				LEN=0			

DATA FRAME Sensor → PC

Byte1 Header	Byte2 Header	Byte3 Header	Byte4 Header	Byte5 Header	Byte6 Header	Byte7 Header	Byte8 Header	Byte9 Data	Byte10 Data	Byte11 Data	Byte12 Data
0x55	<order>	<ARG> (lo byte)	<ARG> (hi byte)	<LEN> (lo byte)	<LEN> (hi byte)	CRC8 (Data)	CRC8 (Header)	Para1 (lo byte)	Para1 (hi byte)	Para2 (lo byte)	Para2 (hi byte)
85 (dec)	2	0	0	60	0	40	122	200	0	0	0
ARG=0				LEN=60				POWER=200		PMODE=0	

Byte13 Data	Byte14 Data	Byte15 Data	Byte16 Data	Byte17 Data	Byte18 Data	Byte19 Data	Byte20 Data	Byte21 Data	Byte22 Data	Byte23 Data	Byte24 Data
Para3 (lo byte)	Para3 (hi byte)	Para4 (lo byte)	Para4 (hi byte)	Para5 (lo byte)	Para5 (hi byte)	Para6 (lo byte)	Para6 (hi byte)	Para7 (lo byte)	Para7 (hi byte)	Para8 (lo byte)	Para8 (hi byte)
0	0	1	0	1	0	1	0	1	16	0	8
BGMODE=0		POLARITY=1		EMODE=0		EBEG=1		EEND=4096		TVAL=2048	

Byte25 Data	Byte26 Data	Byte27 Data	Byte28 Data	Byte29 Data	Byte30 Data	Byte31 Data	Byte32 Data	Byte33 Data	Byte34 Data	Byte35 Data	Byte36 Data
Para9 (lo byte)	Para9 (hi byte)	Para10 (lo byte)	Para10 (hi byte)	Para11 (lo byte)	Para11 (hi byte)	Para12 (lo byte)	Para12 (hi byte)	Para13 (lo byte)	Para13 (hi byte)	Para14 (lo byte)	Para14 (hi byte)
200	0	200	0	2	0	0	0	0	0	0	0
TOLLO=200		TOLHI=200		AVGERAGE=2		EXTRIGMODE=0		ANAMODE=0		OPMODE=0	

Byte37 Data	Byte38 Data	Byte39 Data	Byte40 Data	Byte41 Data	Byte42 Data	Byte43 Data	Byte44 Data	Byte45 Data	Byte46 Data	Byte47 Data	Byte48 Data
Para15 (lo byte)	Para15 (hi byte)	Para16 (hi byte)	Para16 (hi byte)	Para17 (lo byte)	Para17 (hi byte)	Para18 (lo byte)	Para18 (hi byte)	Para19 (lo byte)	Para19 (hi byte)	Para20 (lo byte)	Para20 (hi byte)
0	0	0	0	25	0	70	0	0	0	4	0
HWMODE=0		VTHDMODE=0		VTHDFIX=25		VTHDAUTO=70		RS232MODE=0		RS232BAUD=4	

Byte49 Data	Byte50 Data	Byte51 Data	Byte52 Data	Byte53 Data	Byte54 Data	Byte55 Data	Byte56 Data	Byte57 Data	Byte58 Data	Byte59 Data	Byte60 Data
Para21 (lo byte)	Para21 (hi byte)	Para22 (hi byte)	Para22 (hi byte)	Para23 (lo byte)	Para23 (hi byte)	Para24 (lo byte)	Para24 (hi byte)	Para25 (lo byte)	Para25 (hi byte)	Para26 (lo byte)	Para26 (hi byte)
0	0	0	0	0	0	10	0	0	0	1	0
SMOOTH=0		ANAZOOM=0		INTRIGMODE=0		TIRGPPIX=10		OUTMODE=0		EXTIME=1	

Byte61 Data	Byte62 Data	Byte63 Data	Byte64 Data	Byte65 Data	Byte66 Data	Byte67 Data	Byte68 Data
Para27 (lo byte)	Para27 (hi byte)	Para28 (lo byte)	Para28 (hi byte)	Para29 (lo byte)	Para29 (hi byte)	Para29 (lo byte)	Para29 (hi byte)
0	0	0	0	0	18	0	0
TOLMODE=0		FREEPARA=0		UMSLOPE=4608			

< ORDER = 8 > : READ MEASUREMENT DATA from sensor

DATA FRAME PC → Sensor

Byte1 Header	Byte2 Header	Byte3 Header	Byte4 Header	Byte5 Header	Byte6 Header	Byte7 Header	Byte8 Header
0x55	<order>	<ARG> (lo byte)	<ARG> (hi byte)	<LEN> (lo byte)	<LEN> (hi byte)	CRC8 (Data)	CRC8 (Header)
85 (dec)	8	0	0	0	0	170	118
ARG=0				LEN=0			

DATA FRAME Sensor → PC

Byte1 Header	Byte2 Header	Byte3 Header	Byte4 Header	Byte5 Header	Byte6 Header	Byte7 Header	Byte8 Header	Byte9 Data	Byte10 Data	Byte11 Data	Byte12 Data
0x55	<order>	<ARG> (lo byte)	<ARG> (hi byte)	<LEN> (lo byte)	<LEN> (hi byte)	CRC8 (Data)	CRC8 (Header)	Para1 (lo byte)	Para1 (hi byte)	Para2 (lo byte)	Para2 (hi byte)
85 (dec)	8	0	0	14	0	325	154	76	11	1	0
ARG=0				LEN=32				E_LEFT = 2892		E_RIGHT = 0	

Byte13 Data	Byte14 Data	Byte15 Data	Byte16 Data	Byte17 Data	Byte18 Data	Byte19 Data	Byte20 Data	Byte21 Data	Byte22 Data	Byte23 Data	Byte24 Data
Para3 (lo byte)	Para3 (hi byte)	Para4 (lo byte)	Para4 (hi byte)	Para5 (lo byte)	Para5 (hi byte)	Para6 (lo byte)	Para6 (hi byte)	Para7 (lo byte)	Para7 (hi byte)	Para7 (lo byte)	Para7 (hi byte)
184	11	1	0	17	0	0	0	0	8	0	0
M_VAL = 3000		EDGE_CNT = 1		UM_VALUE = 17				TEACH_VAL = 2048		MV_FIRST = 0	

Byte25 Data	Byte26 Data	Byte27 Data	Byte28 Data	Byte29 Data	Byte30 Data	Byte31 Data	Byte32 Data	Byte33 Data	Byte34 Data	Byte35 Data	Byte36 Data
Para3 (lo byte)	Para3 (hi byte)	Para4 (lo byte)	Para4 (hi byte)	Para5 (lo byte)	Para5 (hi byte)	Para6 (lo byte)	Para6 (hi byte)	Para7 (lo byte)	Para7 (hi byte)	Para7 (lo byte)	Para7 (hi byte)
184	11	184	11	17	0	0	0	32	3	0	0
MV_LAST = 0		ANA_MAX = 3000		ANA_MIN = 17		IN_STATE = 0		VIDEO_MAX = 800		TRIG_PIX	

Byte37 Data	Byte38 Data	Byte37 Data	Byte38 Data
Para3 (lo byte)	Para3 (lo byte)	Para3 (lo byte)	Para3 (hi byte)
0	0	0	0
DYN_POWER=0		AUTO_TOL = 0	

< ORDER = 11 > : RESET MAX/MIN VALUE OF ANALOG-OUTPUT at sensor

DATA FRAME PC → Sensor

Byte1 Header	Byte2 Header	Byte3 Header	Byte4 Header	Byte5 Header	Byte6 Header	Byte7 Header	Byte8 Header
0x55	<order>	<ARG> (lo byte)	<ARG> (hi byte)	<LEN> (lo byte)	<LEN> (hi byte)	CRC8 (Data)	CRC8 (Header)
85 (dec)	11	0	0	0	0	170	118
ARG=0				LEN=0			

DATA FRAME Sensor → PC

Byte1 Header	Byte2 Header	Byte3 Header	Byte4 Header	Byte5 Header	Byte6 Header	Byte7 Header	Byte8 Header
0x55	<order>	<ARG> (lo byte)	<ARG> (hi byte)	<LEN> (lo byte)	<LEN> (hi byte)	CRC8 (Data)	CRC8 (Header)
85 (dec)	190	0	0	0	0	170	195
ARG=0				LEN=0			

< ORDER = 13 > : STORE NEW VIDEO-AUTO-THRESHOLD at sensor (RAM)

The new video threshold is calculated from the actual intensity profile over the CCD-line.
 The <ARG> = VIDEO-THD-AUTO [%] is used for calculation. Range: 1 to 99
 ATTENTION: Make sure that the laser-beam is not covered before you start this action!

DATA FRAME PC → Sensor

Byte1 Header	Byte2 Header	Byte3 Header	Byte4 Header	Byte5 Header	Byte6 Header	Byte7 Header	Byte8 Header	
0x55	<order>	<ARG> (lo byte)	<ARG> (hi byte)	<LEN> (lo byte)	<LEN> (hi byte)	CRC8 (Data)	CRC8 (Header)	
85	13	70	0	0	0	170	14	
VTHD_AUTO=70			LEN=0					

New AUTO-VIDEO-THRESHOLD [%] value is set by <ARG> value:

DATA FRAME Sensor → PC

Byte1 Header	Byte2 Header	Byte3 Header	Byte4 Header	Byte5 Header	Byte6 Header	Byte7 Header	Byte8 Header	
0x55	<order>	<ARG> (lo byte)	<ARG> (hi byte)	<LEN> (lo byte)	<LEN> (hi byte)	CRC8 (Data)	CRC8 (Header)	
85 (dec)	13	0	0	0	0	170	195	
ARG=0			LEN=0					

< ORDER = 14 > : STORE NEW VIDEO-AUTO-THRESHOLD at sensor (EEPROM)

The new video threshold is calculated from the actual intensity profile over the CCD-line.
 The <ARG> = VIDEO-THD-AUTO [%] is used for calculation. Range: 1 to 99
 ATTENTION: Make sure that the laser-beam is not covered before you start this action!

DATA FRAME PC → Sensor

Byte1 Header	Byte2 Header	Byte3 Header	Byte4 Header	Byte5 Header	Byte6 Header	Byte7 Header	Byte8 Header	
0x55	<order>	<ARG> (lo byte)	<ARG> (hi byte)	<LEN> (lo byte)	<LEN> (hi byte)	CRC8 (Data)	CRC8 (Header)	
85	14	70	0	0	0	170	14	
VTHD_AUTO=70			LEN=0					

New AUTO-VIDEO-THRESHOLD [%] value is set by <ARG> value:

DATA FRAME Sensor → PC

Byte1 Header	Byte2 Header	Byte3 Header	Byte4 Header	Byte5 Header	Byte6 Header	Byte7 Header	Byte8 Header	
0x55	<order>	<ARG> (lo byte)	<ARG> (hi byte)	<LEN> (lo byte)	<LEN> (hi byte)	CRC8 (Data)	CRC8 (Header)	
85 (dec)	14	0	0	0	0	170	195	
ARG=0			LEN=0					

< ORDER = 190 > : CHANGE BAUDRATE at sensor (RAM)

DATA FRAME PC → Sensor

Byte1 Header	Byte2 Header	Byte3 Header	Byte4 Header	Byte5 Header	Byte6 Header	Byte7 Header	Byte8 Header
0x55	<order>	<ARG> (lo byte)	<ARG> (hi byte)	<LEN> (lo byte)	<LEN> (hi byte)	CRC8 (Data)	CRC8 (Header)
85 (dec)	190	1	0	0	0	170	14
ARG=1				LEN=0			

New baud rate is set by <ARG> value:

ARG=0: baud rate = 9600

ARG=1: baud rate = 19200

ARG=2: baud rate = 38400

ARG=3: baud rate = 57600

ARG=4: baud rate = 115200

DATA FRAME Sensor → PC

Byte1 Header	Byte2 Header	Byte3 Header	Byte4 Header	Byte5 Header	Byte6 Header	Byte7 Header	Byte8 Header
0x55	<order>	<ARG> (lo byte)	<ARG> (hi byte)	<LEN> (lo byte)	<LEN> (hi byte)	CRC8 (Data)	CRC8 (Header)
85 (dec)	190	0	0	0	0	170	195
ARG=0				LEN=0			

< ORDER = 9 > : GET VIDEO-DATA INFORMATION of sensor

ATTENTION: Only 256 pixel of the CCD-line are transferred!

The <ARG> value determines the source of the VIDEO-DATA-INFORMATION

ARG = 0 : CCD-VIDEO-RAM-DATA

ARG = 1 : VIDEO-THRESHOLD-DATA

DATA FRAME PC → Sensor

Byte1 Header	Byte2 Header	Byte3 Header	Byte4 Header	Byte5 Header	Byte6 Header	Byte7 Header	Byte8 Header
0x55	<order>	<ARG> (lo byte)	<ARG> (hi byte)	<LEN> (lo byte)	<LEN> (hi byte)	CRC8 (Data)	CRC8 (Header)
85 (dec)	9	0	0	0	0	170	185
ARG=0				LEN=0			

DATA FRAME Sensor → PC

Byte1 Header	Byte2 Header	Byte3 Header	Byte4 Header	Byte5 Header	Byte6 Header	Byte7 Header	Byte8 Header	Byte9 Data	Byte10 Data	Byte11 Data	Byte12 Data
0x55	<order>	<ARG> (lo byte)	<ARG> (hi byte)	<LEN> (lo byte)	<LEN> (hi byte)	CRC8 (Data)	CRC8 (Header)	Para1 (lo byte)	Para1 (hi byte)	Para2 (lo byte)	Para2 (hi byte)
85 (dec)	9	0	0	8	1	xxx	185	200	0	220	0
ARG=0				LEN=8+256				PIX1=200		PIX2=220	

Byte13 Data	Byte14 Data	Byte15 Data	Byte16 Data	Byte17 Data	Byte18 Data	Byte19 Data	Byte20 Data	Byte21 Data	Byte22 Data	Byte23 Data	Byte24 Data
Para3 (lo byte)	Para3 (hi byte)	Para4 (lo byte)	Para4 (hi byte)	Para5 (lo byte)	Para5 (hi byte)	Para6 (lo byte)	Para6 (hi byte)	Para7 (lo byte)	Para7 (hi byte)	Para8 (lo byte)	Para8 (hi byte)
240	0	0	1	44	1	124	1	0	2	88	2
PIX3=240		PIX4=256		PIX5=300		PIX6=380		PIX7=512		PIX8=600	

Byte25 Data	Byte26 Data	Byte27 Data	Byte28 Data	Byte29 Data	Byte30 Data	Byte31 Data	Byte32 Data	Byte33 Data	Byte34 Data	Byte35 Data	Byte36 Data
Para9 (lo byte)	Para9 (hi byte)	Para10 (lo byte)	Para10 (hi byte)	Para11 (lo byte)	Para11 (hi byte)	Para12 (lo byte)	Para12 (hi byte)	Para13 (lo byte)	Para13 (hi byte)	Para14 (lo byte)	Para14 (hi byte)
168	2	170	2	188	2	188	2	198	2	208	2
PIX9=680		PIX10=682		PIX11=700		PIX12=700		PIX13=710		PIX14=720	

Byte37 Data	Byte38 Data	Byte39 Data	Byte40 Data	Byte41 Data	Byte42 Data	Byte43 Data	Byte44 Data	Byte45 Data	Byte46 Data	Byte47 Data	Byte48 Data
Para15 (lo byte)	Para15 (hi byte)	Para16 (lo byte)	Para16 (hi byte)	Para17 (lo byte)	Para17 (hi byte)	Para18 (lo byte)	Para18 (hi byte)	Para19 (lo byte)	Para19 (hi byte)	Para20 (lo byte)	Para20 (hi byte)
34	3	32	3	32	3	22	3	19	3	20	3
PIX15=802		PIX16=800		PIX17=800		PIX18=790		PIX19=787		PIX20=788	



Byte49 Data	Byte50 Data	Byte51 Data	Byte52 Data	Byte53 Data	Byte54 Data	Byte55 Data	Byte56 Data	Byte57 Data	Byte58 Data	Byte59 Data	Byte60 Data
Para21 (lo byte)	Para21 (hi byte)	Para22 (lo byte)	Para22 (hi byte)	Para23 (lo byte)	Para23 (hi byte)	Para24 (lo byte)	Para24 (hi byte)	Para25 (lo byte)	Para25 (hi byte)	Para26 (lo byte)	Para26 (hi byte)
124	1	44	1	0	1	240	0	220	0	200	0
PIX251=380		PIX252=300		PIX253=256		PIX254=240		PIX255=220		PIX256=200	